



INSTRUCTION MANUAL

DSR-2116 DSR-2108

Digital Video Recorder

About this manual

Before installing and using this unit, please read this manual carefully.
Be sure to keep it handy for later reference.



DSR-2116

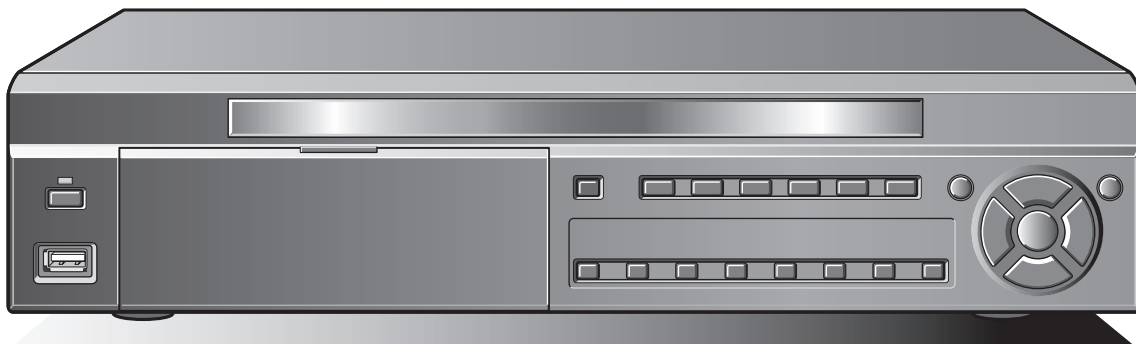

DSR-2108



- Refer to the included CD-ROM for the German, French, Spanish and Italian “INSTRUCTION MANUAL”.
- Die “BEDIENUNGSANLEITUNG” in den Sprachen Deutsch, Französisch, Spanisch und Italienisch finden Sie auf der beiliegenden CD-ROM.
- Utilisez le CD-ROM fourni pour consulter le “MANUEL D’INSTRUCTIONS” en allemand, français, espagnol et italien.
- Consulte en el CD-ROM suministrado el “MANUAL DE INSTRUCCIONES” en alemán, francés, español e italiano.
- Per il “MANUALE DI ISTRUZIONI” in Tedesco, Francese, Spagnolo e Italiano, fare riferimento al CD-ROM allegato.

Table of Contents

Safety precautions	ii	I Setting the RS485 SET	40
These precautions must be followed for safety reasons.	iii	J Setting the PTZ CONTROL	40
Follow the points outlined below for proper use	vi	K Setting the LANGUAGE	40
Main Features	1	L Setting a REMOTE CONTROL ID	41
Main parts replacement timings	1	NETWORK settings	42
Accessories	1	A Setting the PORT	42
About the split screen display	2	B Setting a CLIENT ACCESS	42
Names and functions of parts	3	C Setting the BANDWIDTH SAVING	42
Names of each part and connections	4	D Setting the NETWORK TYPE	43
Basic connections	4	E Setting the DDNS	44
Network connection (LAN)	5	F Setting the SEND E-MAIL	45
Connecting to the RS-485 control terminal	6	G Setting the NTP SET	46
Switching the power on / off	7	HDD SET settings	47
A Switching the power on	7	A Setting the OVERWRITE	47
B Switching the power off	7	B FORMAT settings	47
Pre-operation preparation	8	C Setting the auto delete function	48
Screen display	8	SERVICE settings	49
A Setting the television system and the monitor output ..	9	A Setting the SAVE SETUP TO A USB	49
B Setting the clock (CLOCK SET)	9	B Setting the LOAD SETUP FROM A USB	49
C Setting the language (LANGUAGE)	11	C Displays the hard disk information	49
D Setting the RS-485 termination switch (SANYO SSP side)	11	Operations using the Network	50
Monitoring the camera videos	12	Connection and settings	50
A Single-screen display	12	Operating environment	50
B Quad-screen display	12	Installing "Sanyo DVR Utility 2000S"	50
C Multi-screen display	13	To uninstall the software	51
D Camera sequencing	13	Connecting to this unit	52
Operating the PTZ dome camera	14	Main screen structure and function of each part	53
1 Connection	14	Function of the operation panel	54
2 Settings	14	Main screen basic operations	55
3 Operation	14	A Switching the display mode of the screen	55
Recording	16	B Recording live video	56
A Real time recording	16	C Freezing the live video	57
B CONTINUOUS recording	17	D The audio is output	57
C MOTION recording	17	E Saving images	57
D ALARM recording	18	F Operating the PTZ dome camera	58
E SCHEDULE recording	19	Search mode operations	59
Playing back recorded videos	21	A Searching and playing recorded video	60
A EVENT SEARCH	22	B Backing up DVR recorded video	61
B TIMELINE SEARCH	23	Setup menu settings	62
C T/D SEARCH	24	A General settings (General)	62
D GO FIRST	24	B Camera designation settings (Site)	63
E GO LAST	24	C Event settings (Event)	64
F LOG	24	D Event log search, view, save (Log View)	64
G BOOKMARK	25	E Record settings (Record)	65
Copying recorded video to recording media	26	F Disk settings (Disk)	65
A Inserting recording media	26	G Version information (About)	65
B Copying live videos	26	Remote Setup	66
C Copying a playback video	27	A Remote Setup operating procedure	66
D Playing back copied videos	27	B Setting the Display	67
Setting the security lock	28	C Setting the Alarm-Set	68
Configuration and function of the Menu settings	29	D Setting the Monitor2	69
LIVE settings	31	E Setting the Record	70
A Setting the OSD and OSD CONTRAST	31	F System settings	72
B Setting the SEQUENCE and SEQUENCE-DWELL TIME ..	31	G Description	73
C Setting the EVENT BEEP	31	H Setting the PTZ Control	73
D Setting a CHANNEL	32	I Setting the Network	74
E Alarm input output settings	32	J Setting the Send E-Mail	75
F Setting the MON2 (Monitor2)-OUT	33	K Setting the NTP	75
RECORD settings	35	L Setting the Storage	75
A Setting the RESOLUTION	35	Operations using the Web browser	76
B Setting a CHANNEL	35	Part names of the remote control	79
C Setting the TIMER SET	36	Specifications	80
D Setting the REAL-TIME RECSET	36	Mounting the hard disk (S-ATA)	81
SYSTEM settings	37		
A Setting the DVR ID	37		
B DESCRIPTION confirmation	37		
C Setting the LOAD DEFAULT	37		
D Setting an ADMIN PASSWORD	38		
E Setting the USER PASSWORD	39		
F Setting a NETWORK PASSWORD	39		
G Setting the DATE FORMAT	40		
H Setting the CLOCK SET	40		

Safety precautions



CAUTION

RISK OF ELECTRIC SHOCK

DO NOT OPEN



CAUTION: TO REDUCE A RISK OF ELECTRIC SHOCK, DO NOT REMOVE COVER (OR BACK). NO USER-SERVICEABLE PARTS INSIDE. REFER SERVICING TO QUALIFIED SERVICE PERSONNEL.

WARNING: To reduce a risk of fire or electric shock, do not expose this product to rain or moisture.



The lightning flash with arrowhead symbol, within an equilateral triangle, is intended to alert the user to the presence of uninsulated "dangerous voltage" within the product's enclosure that may be of sufficient magnitude to constitute a risk of electric shock to persons.



The exclamation point within an equilateral triangle is intended to alert the user to the presence of important operating and maintenance (servicing) instructions in the literature accompanying the product.

CAUTION: Changes or modifications not expressly approved by the manufacturer may void the user's authority to operate this equipment.

This equipment has been tested and found to comply with the limits for a Class B digital device, pursuant to Part 15 of the FCC Rules.

These limits are designed to provide reasonable protection against harmful interference in a residential installation. This equipment generates, uses and can radiate radio frequency energy and, if not installed and used in accordance with the instructions, may cause harmful interference to radio communications.

However, there is no guarantee that interference will not occur in a particular installation.

If this equipment does cause harmful interference to radio or television reception, which can be determined by turning the equipment off and on, the user is encouraged to try to correct the interference by one or more of the following measures.

- Reorient or relocate the receiving antenna.
- Increase the separation between the equipment and receiver.
- Connect the equipment into an outlet on a circuit different from that to which the receiver is connected.
- Consult the dealer or an experienced radio/TV technician for help.

CAUTION

This product employs a Laser System.

To ensure proper use of this product, Please read this owner's manual carefully and retain it for future reference.

Should the unit require maintenance, contact an authorized service center.

Use of controls, adjustments or the performance of procedures other than those specified herein may result in hazardous radiation exposure.

To prevent direct exposure to laser beam, do not try to open the enclosure. Visible laser radiation when open. **DO NOT STARE INTO BEAM.**

Declaration of Conformity

Model Number : DSR-2116, DSR-2108
 Trade Name : SANYO
 Responsible party : SANYO FISHER COMPANY
 Address : 21605 Plummer Street, Chatsworth, California 91311
 Telephone No. : (818) 998-7322

- This device complies with Part 15 of the FCC Rules. Operation is subject to the following two conditions:
 - (1) this device may not cause harmful interference, and
 - (2) this device must accept any interference received, including interference that may cause undesired operation.

For the customers in Canada

This class B digital apparatus complies with Canadian ICES-003.

CAUTION

Danger of explosion if battery is incorrectly replaced. Replace only with the same or equivalent type recommended by the manufacturer. Discard used batteries according to the manufacture's instructions.

FOR CALIFORNIA, U.S.A. ONLY

This product contains a CR Coin Lithium Battery which contains Perchlorate Material - special handling may apply. See www.dtsc.ca.gov/hazardouswaste/perchlorate.

Licensed Under U.S. Patent No. 4,974,088



Please note:
 Your SANYO product is designed and manufactured with high quality materials and components which can be recycled and reused.

This symbol means that electrical and electronic equipment, at their end-of-life, should be disposed of separately from your household waste. Please dispose of this equipment at your local community waste collection/recycling centre. In the European Union there are separate collection systems for used electrical and electronic products. Please help us to conserve the environment we live in!

This symbol mark and recycle system are applied only to EU countries and not applied to the countries in the other area of the world.

FOR RUSSIAN USERS

This product is certified by an official certification company which is authorized by the Russian Federation.



АЯ46

ДЛЯ ПОЛЬЗОВАТЕЛЕЙ РОССИИ

Данная продукция сертифицирована официальным органом по сертификации Российской Федерации.

Safety precautions

These precautions must be followed for safety reasons.

Warning

■ Do not use if the unit emits smoke, strange sounds are heard or odor is emitted.

Continued use may cause electrocution and/or fire. Immediately remove the power plug from the outlet. Once the unit stops emitting smoke, consult the dealership where this unit was purchased or factory shop for repairs.

Do not attempt repairs on your own.



■ Disassembly prohibited

- Do not place your hand inside this unit as this may cause fire and/or electrocution.
- Consult the dealership where this unit was purchased or factory shop for diagnostics, adjustments, and repairs.



■ Make sure the power cable is not damaged.

- Always use the power cable supplied with the unit.
- Do not place heavy objects on the power cable or place the power cable near heating equipment. Also, do not bend the power cable forcefully, work upon or staple it.

A damaged power cable may result in fire and/or electrocution.

- Should the power cable become damaged it must be replaced by the dealership where this unit was purchased or factory shop.



■ Do not place any foreign objects inside the unit.

- Do not insert or push in any metal or combustible objects through openings such as air ducts. This may cause fire and/or electrocution.
- In the event that a foreign object is inside the unit, turn off and unplug the unit. Consult the dealership where this unit was purchased or factory shop. Continued use may result in fire and/or electrocution.



■ Do not place a container holding water or other liquids above the unit when it is connected to power.

In the event that water gets inside the unit, turn off and unplug the unit. Consult the dealership where this unit was purchased or factory shop.

Continued use may result in a fire or electrocution.



■ Make sure there is no dust accumulation on the power plug or the outlet.

- Dust accumulation may result in a short-circuit and heat generation and cause fire.
- Be especially careful when using an outlet situated in a room exposed to high humidity, condensation and/or dust, or in a kitchen.
- Periodically remove the power plug from the outlet and clean any dust and dirt between the plug and the outlet.



■ Do not allow the unit to get wet.

- This unit is not waterproof. Do not expose the unit to water. This may cause fire and/or electrocution.
Do not use in a bath or shower room.
- In the event that the internal components have been exposed to water, turn the power off and remove the power plug from the outlet. Consult the dealership where this unit was purchased or factory shop. Continued use may cause electrocution and/or fire.



■ Caution when connecting the power cable

- Connect the power plug directly with the outlet. Faulty connection may result in heat generation and cause fire.
- Do not use the power cable while it is tied in a bundle. This may result in heat generation and cause fire.
- When using the extension cord supplied, make sure the power consumption of the connected unit does not exceed the electrical rating of the extension cord. Higher power consumption may result in heat generation and cause fire.



Safety precautions

Warning

■ Do not use during thunder/thunder storms.

Do not use during thunder/thunder storms. Never touch the connection cable during thunder/thunder storms. This may cause electrocution.



■ Do not place in an unstable position.

- Doing so may cause accidents and/or breakdowns through falling or toppling.
- In the event that the unit has been dropped or the casing has been damaged, turn the power off and remove the power plug from the outlet. Consult the dealership where this unit was purchased or factory shop. Continued use may cause electrocution and fire.



■ Do not expose to shock or vibration.

Stored data may be damaged or lost through hard-disk breakdowns caused by shock/vibration.



■ Do not use this unit in areas where it is exposed to the possibility of explosion.

Do not use this unit in areas where explosive and/or flammable gases are present. This may cause fire and/or explosion.



Caution

■ Do not pull on the power cable when removing the power plug from the outlet.

Hold the power plug when disconnecting the power cable from the outlet. Pulling on the power cable may damage the cord. This may cause fire and/or electrocution.



■ Do not touch the power plug with wet hands.

Doing so may result in electrocution.



■ Do not sit on.

Doing so may cause the unit to fall, be damaged and/or result in injury.



■ Make sure the cables are connected properly.

Connect and install the power cable and connection cable very carefully. Tripping over the cable may result in the unit capsizing or falling and cause injury.



■ Do not place heavy objects on connected units.

Doing so may affect the stability of the unit and cause it to fall which may result in injury. Doing so may also damage the unit depending on the weight of the object.



■ Shipment and portability

- Never move this unit while the power is turned on.
- When shipping, remove the power plug from the outlet, confirm that the connection cable has been removed, and store in original packaging. Ship using a method that causes the least amount of shock and/or damage to this unit. Also, do not drop this unit.



■ Maintenance when the unit is going to remain unused for long periods of time

Remove the power plug from the outlet. Carrying out maintenance without removing the power plug may cause electrocution.



Safety precautions

Caution

■ Cleaning the internal components

Consult the dealership where this unit was purchased or factory shop for cleaning internal components. Leaving the unit unused for long periods of time may attract dust to the internal components, which in turn may cause fire and/or breakdowns.



■ Do not block the cooling fans or air ducts.

- This unit is equipped with air ducts and cooling fans in order to assist the ventilation of hot air produced by the hard disk drive.
Placing covers, placing in a case, or placing inside bookcases may cause heat build up, and may result in fire and/or electrocution.



■ When the unit is set up in a rack

The hard disk drive and so on generates heat, which may cause operation errors and damage, therefore leave the specified open spaces when setting up the unit. Also, use only an open framed rack without back panels.

- Leave the specified open space between the unit and the rack
 - Leave 1 cm or more on the upper and lower side
 - Leave 5 cm or more on both sides
- Leave open space of 10 cm or more between the rear of the rack and the wall

■ Do not expose to extreme temperatures or humidity changes.

- Do not place in areas where the unit will be exposed to extreme temperatures (± 10 degrees C per hour) or humidity changes.



■ Points on unit positioning

This unit is constructed using precision electronic parts. Avoid placing it in areas described below as this may cause faulty operation and/or breakdowns.



- In direct sunlight
- In places exposed to water
- In the vicinity of cooling and heating units or humidifiers
- Near the air conditioner where the unit is exposed to cool air
- Dusty areas
- Areas that contain fire hazards
- Areas that contain magnetic items
- In the vicinity of volatile substances
- Areas where the unit will be exposed to constant vibration (in trains, cars, etc.)

■ Cautionary points on condensation

Droplets may form on the outside when very cold water is poured into a cup. In the same way, droplets may form around the internal components of this unit. This is called condensation.

Do not use this unit if condensation has formed.

Using this unit while condensation is formed may cause breakdowns. In the event of sudden sharp temperature changes, turn off the power and do not use this unit until the temperature of the room where it is positioned stabilizes (about 2 hours).

Condensation will not occur while the power is turned on.

When condensation is likely to occur ...

Use the unit after turning the power off and leaving it for 1~2 hours.

Safety precautions

Follow the points outlined below for proper use

■ Back up battery.

- This unit has got a built-in lithium battery used to back up the clock function. The battery continues to operate the clock even when there is a power disruption.
- The life expectancy of the battery is approximately 2 years. If the battery runs out or leaks, the clock resets when the power is turned off. When the power is turned back on (or when rebooted), a warning message to replace the battery is displayed on the monitor screen. Consult the dealership where this unit was purchased or a "Repair Service Center".

Battery fluid leaks

In the event that the battery fluid has leaked rinse hands/ clothes thoroughly with water.

Loss of eyesight may result if battery fluid enters the eyes. Do not rub the eyes. Immediately rinse with clean water and consult a physician.

When disposing of this unit

Consult the dealership where this unit was purchased for information concerning the disposal of the lithium battery.



CAUTION:

RISK OF EXPLOSION IF BATTERY IS REPLACED BY AN INCORRECT TYPE.

DISPOSE OF USED BATTERIES ACCORDING TO THE INSTRUCTIONS

■ If unused for a lengthy period of time

Remove the power plug from the outlet. Remember to occasionally turn the power on in order to maintain correct function.

■ Pre-confirm important recording assignments

Recording and/or playback functions may be unavailable due to hard-drive or connecting unit failures. Always confirm that recording can be carried out successfully before carrying out important recording assignments. The recorded content cannot be guaranteed.

It is recommended to periodically back up data in order to prevent the loss of the data in the event of breakdowns, recording faults or accidents.

■ Maintaining this unit

Turn the power off and remove the power plug from the outlet. Wipe away any dust using a soft cloth.

When the stains are hard to remove...

Soak a cloth in water with diluted neutral detergent and wring it. Wipe the stain with the moistened cloth and finally dry off with a dry cloth.

CAUTION:

- Do not use paint thinner, benzene, or any other alcohol based agents for cleaning. The exterior may deteriorate or the paint may wear off.
- Follow the instructions supplied on the packaging of the chemical cleaning agent.
- Do not spray volatile substances, such as insecticides, etc. onto the unit. Also, avoid extended contact with rubber or vinyl products.
This may cause exterior damage or wear the paint off.

■ Copyright information

- This manual and software are copyrighted to SANYO Electric Co., Ltd.
- Microsoft, Windows and Internet Explorer are trademarks or registered trademarks of Microsoft USA in the USA and in other countries.
- Intel and Pentium is a trademark or registered trademark of Intel USA in the USA and in other countries.
- Brand and product names used in this manual are the trademarks or registered trademarks of their respective companies.

Except for personal use, copyright law prohibits the use of recorded copyrighted images without the permission of the copyright holder.

■ Personal data protection

Images or footage recorded by the camera video system in which people are captured and can be identified are considered to be personal information and fall within the scope of the Personal Data Protection Law. It is the responsibility of the user to operate the system in accordance with the above law.

Main Features

- Long-time MPEG4 recording
- Moving video monitoring in split screen
- Coaxial superimposed type (COAX) camera control
- Maximum recording speed
DSR-2116: 240 IPS (NTSC) or 200 IPS (PAL)
DSR-2108: 120 IPS (NTSC) or 100 IPS (PAL)
- 4ch audio recording
- Image downloading to USB memory
- Remote operation from PC via network
- VGA video output
- Built-in disc drive (DVD-R or CD-R/RW)
- Comes with IR remote control and DVR utility software

Main parts replacement timings

Continued use of this unit in a 25°C environment may result in wear and deterioration of the parts of the unit. We recommend you replace the following parts according to the timings listed below. The replacement timings listed are approximate and do not guarantee the performance of the part in question.

■ **Hard disk:** 2 years (25°C environment)

The life expectancy of each part depends on the environment in which the unit is used. However, the head and motor are particularly prone to wear and deterioration. Therefore, writing errors are more likely to occur after two years of use.

■ **Cooling fan:** 3 years (25°C environment)

Cooling fan failure causes higher internal temperatures which may result in a faulty hard disk. Periodically check whether the cooling fan is working properly.

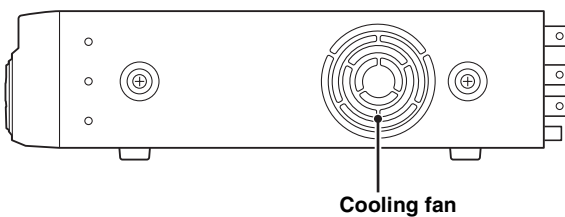

Memo: This unit is equipped with two cooling fans on the right and at the rear. The cooling fan on the right may be replaced.

■ **Battery:** 2 years (25°C environment)

Accessories

Check that all the parts shown below are supplied.

- ① Power cable (x2)
 - ② Remote control
* 2 “AAA” batteries are necessary for the remote control.
(Batteries not included)
 - ③ HDD mounting bracket (x2)
 - ④ Rubber pad (x8)
 - ⑤ Mounting bracket screws (x8)
 - ⑥ HDD fixing screw (x8)
 - ⑦ S-ATA cable (x2)
 - ⑧ CD-ROM
- Instruction Manual (Digital Video Recorder)

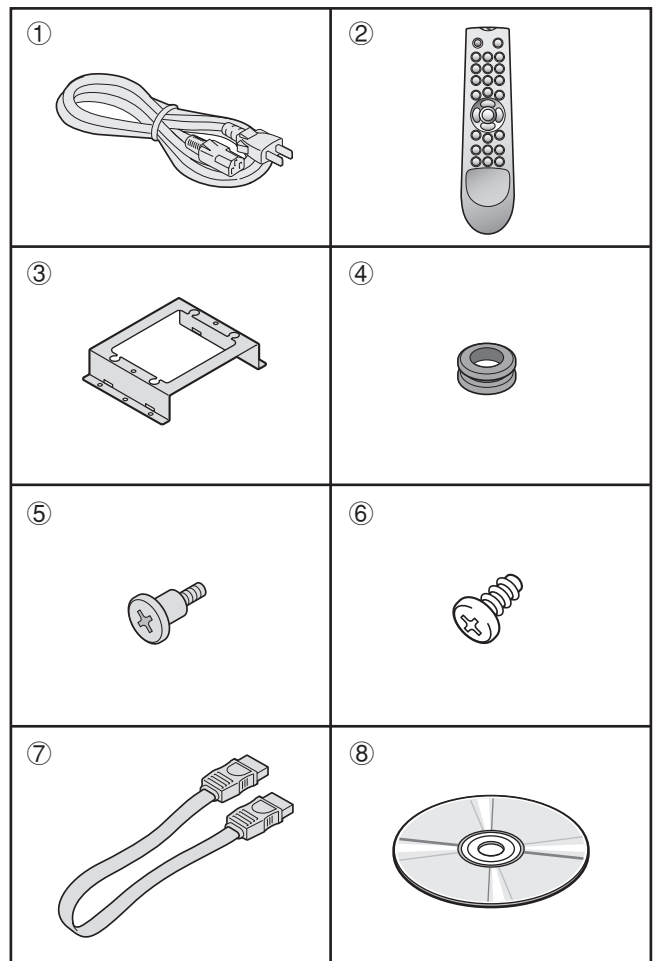

About the split screen display

This manual is common to 2 models. Major differences between these two models are, the number of channel selection buttons available on the front panel and the number of input/output terminals available on the rear panel.

As a result, the number of split screens that can be displayed on the monitor is different, as shown below.

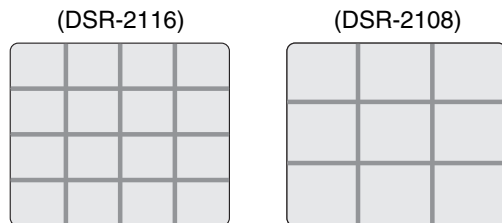

Warning

The hard disk is a precision instrument. To avoid damage, handle the hard disk with care and do not expose it to shock. Do not block the ventilation holes and do not allow the cooling fan to stop. Doing so may cause heat build up and may shorten the life expectancy of the hard disk.

This unit is designed to be positioned horizontally. Do not position vertically.

Do not expose to shock or vibration and do not transport while power is turned on.

Always turn the power off when moving in and out of racks or other shelves.

Do not remove the power plug while recording or playing images back.

Do not move the unit for approximately 30 seconds after turning the power off.

The hard disk continues to rotate for a short duration after the power has been turned off. The unit is further susceptible to damage through shock and vibration during that period. It is imperative that you do not move the unit during that time.

Do not expose to shock or vibration.

Avoid placing this unit directly on the floor. Make sure that the four stands attached to the base of this unit are used when placing it on the floor.

Always use the original packaging (packaging supplied at the time of purchase), when shipping the unit.

Make sure you use the packaging materials supplied at the time of the original purchase when shipping the unit or a single internal component of the unit. Select a shipping method that will cause the least amount of shock to the unit during shipping.

Consult the dealership where this unit was purchased for hard disk replacement.

- The hard disk is vulnerable to static electric shocks. Take appropriate measures to prevent exposure to static electricity.
- Unpackaged drives should be placed horizontally with their base plate facing upwards on top of a soft cloth. Exposing the hard disk to shocks and vibration may cause breakdowns.
- Do not expose the drive to shocks and/or vibrations when removing/tightening the screws at the time of hard disk replacement. Firmly tighten the screws after replacement.

Names and functions of parts

Front panel

(DSR-2116)

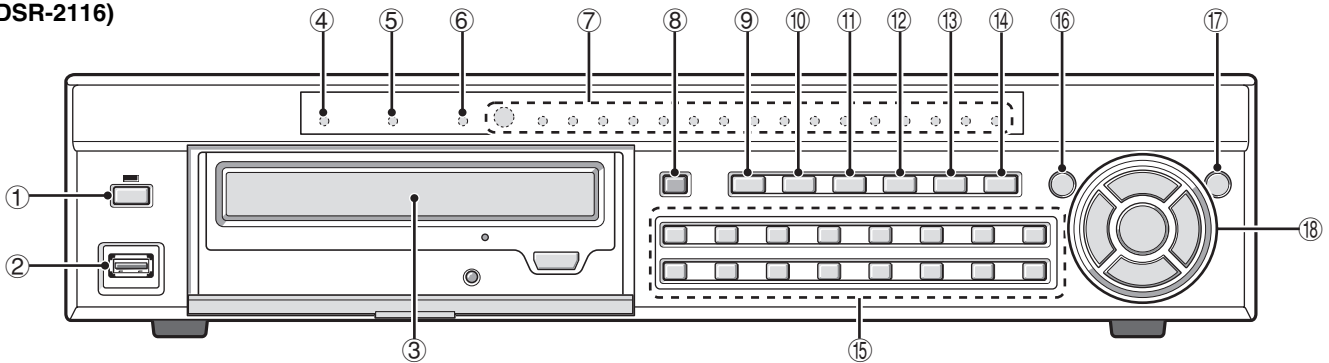

- ① **Power button and indicator (⏻)**
- ② **USB terminal (USB) (Exclusively for 2.0) (P26)**
To save video, connect a USB memory.
- ③ **Disc drive**
To save video, insert a DVD-R or CD-R/RW.
To open and close the insert tray, open the panel and press the button.
- ④ **LAN indicator (LAN)**
The indicator blinks when the unit is connected and used through the LAN cable.
- ⑤ **Alarm indicator (ALARM)**
The indicator lights when an alarm is set off.
- ⑥ **Hard disk drive indicator (HDD)**
The indicator lights when the hard disk is being accessed.
- ⑦ **Recording indicator**
The channel number being recorded lights.
- ⑧ **Record/Stop button (REC/STOP) (P16)**
Starts/Stops the recording of the monitored live image displayed.
- ⑨ **Automatic camera scrolling button (SEQ) (P13)**
Automatically switches through and displays the images of each live.
- ⑩ **Quad-screen display button (QUAD) (P13)**
The monitor video is displayed on quad-screen.
- ⑪ **Multi button (MULTI) (P13)**
The monitor video is displayed on multi-16 or multi-9 screen.
In DSR-2108, the monitor video is displayed on multi-8 screen.
- ⑫ **Mark/Copy button (MARK/COPY) (P26)**
Switches to image saving mode.
- ⑬ **Search button (SEARCH) (P22)**
Switches to recorded-images searching mode.
- ⑭ **Pan/Tilt/Zoom button (PTZ) (P14)**
Operates the Pan/Tilt/Zoom/Focus mode of the PTZ dome camera.
- ⑮ **Camera channel selection buttons (P12)**
The video of the selected channel is displayed on single-screen.
Also used to enter a password.
(DSR-2108)
- ⑯ **Menu button (MENU) (P9/30)**
Displays the settings menu screen and switches to setting mode.
- ⑰ **Exit/Stop button (EXIT/STOP) (P17)**
During settings: Returns to the previous screen.
During playback: Interrupts playback operation.

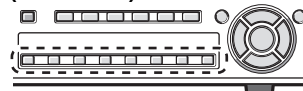

Memo: A security lock can be set by holding the button down. (P28)

⑱ Control button

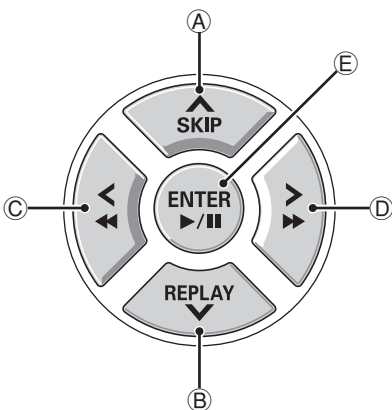

	Playback in progress	Setting in progress (Cursor operation)
A	Skip button (SKIP): The player jumps one minute forward.	▲ : Moves the cursor upward.
B	Replay button (REPLAY): The player jumps one minute backward.	▼ : Moves the cursor downward.
C	◀ button: The player fast rewinds.	◀ : Changes the settings value or moves the cursor to the left.
D	▶▶ button: The player fast-forwards.	▶ : Changes the settings value or moves the cursor to the right.
E	▶/ button: The player displays a still image. Plays the image selected during the image search operation.	ENTER : Sets the selected item or displays the settings screen.

Names of each part and connections

Rear panel

Basic connections



- Do not turn this unit on before all the connections are complete. Read the instruction manual of each unit carefully.
- Make sure each unit is connected properly as faulty connection may result in the unit emitting smoke and/or being damaged.
- Feed additional units with the same power source. Stored data may be lost.

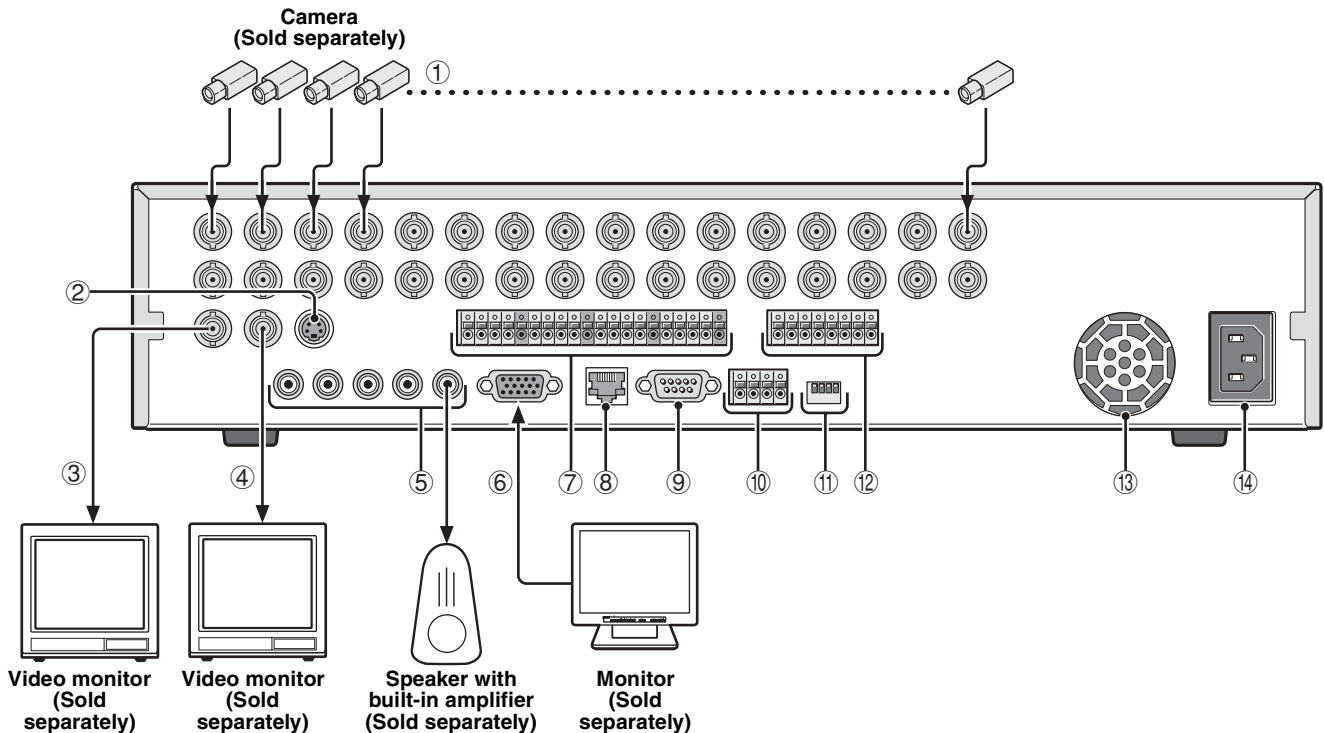

- ① Video input terminal (VIDEO IN/LOOP OUT)
- ② Video output terminal (S-VIDEO)
- ③ Monitor 2 video output terminal (MON2)
- ④ Video output terminal (MAIN)
- ⑤ Audio input/output terminal (AUDIO IN: CH1 - CH4/OUT1)
- ⑥ VGA (Video Graphics Array) output terminal
Connects to the PC VGA monitor.
- ⑦ External sensor terminal (ALARM IN)
- ⑧ Network terminal (LAN: P5)
- ⑨ RS-232C terminal (RS-232C)
For maintenance purposes.
- ⑩ RS-485 control terminal (RS-485: P6)

- ⑪ System changeover switch (SWITCH)
TERMINATE: RS-485 termination switch (P11)
RSV: For maintenance purposes.
VGA: Monitor selection switch (P9)
PAL: Television mode (PAL/NTSC) switching switch (P9)
- ⑫ Alarm output terminal (ALARM OUT: CH1 - CH4)
When the configured alarm output conditions are met, a relay signal is output to one or more external alarm devices connected to the alarm output terminals. These terminals are normally open.

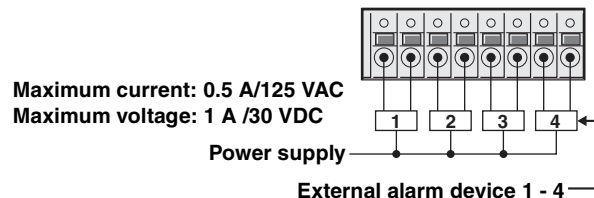

- ⑬ Cooling fan
- ⑭ Power socket

This equipment is indoor use and all the ethernet wiring are limited to inside of the building.

Names of each part and connections

Network connection (LAN)

LAN connection

■ Using the switching hub

Use a 10BASE-T/100BASE-TX CAT 5 LAN cable.

When controlling the network, connect to hubs such as the switching hub using an Ethernet cable.

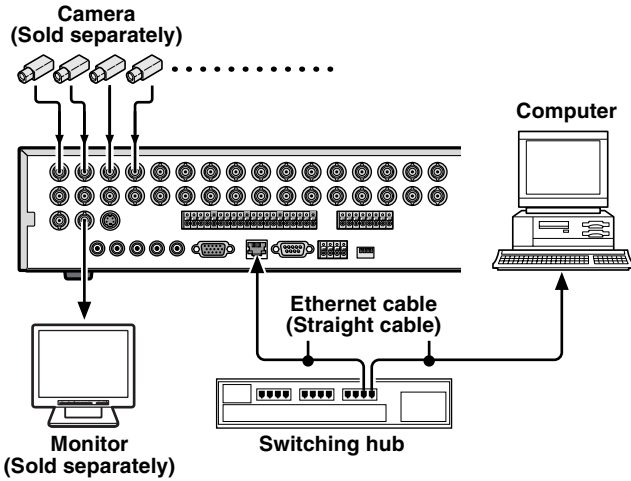

Internet (DHCP, ADSL) connection

Connect to the Internet using a router and the like.

When connecting to an ADSL modem or other device, read the instruction manual of the device for information on how to connect.

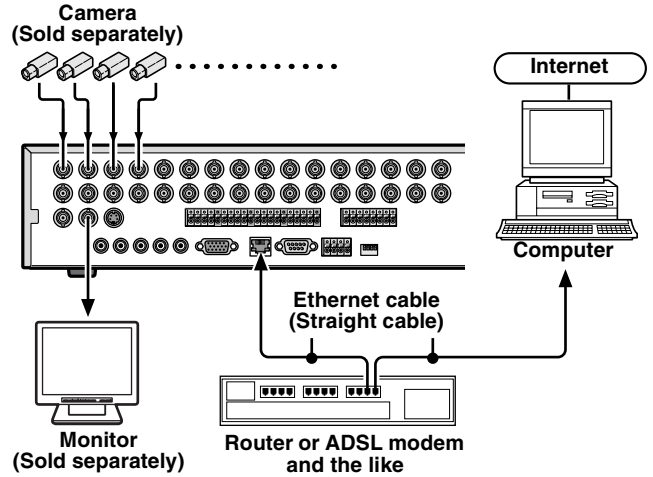

■ Without using a switching hub

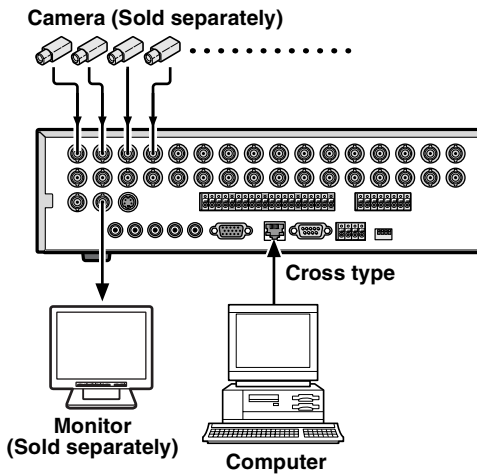

Memo: The type of network must be set on the NETWORK screen. (P42)

Names of each part and connections

Connecting to the RS-485 control terminal

Remote systems such as system controllers and PTZ dome cameras are connected to the RS-485 control terminal. Check the manufacturer of the units to be connected and connect the units to the appropriate terminal signals (A/B).



1	A (SANYO SSP)	To connect a Sanyo PTZ dome camera or system (SANYO SSP) controller
2	B (SANYO SSP)	
3	A (EXCEPT SANYO)	To connect a third-party camera
4	B (EXCEPT SANYO)	

If a system controller is connected

This unit can be operated through the controller.

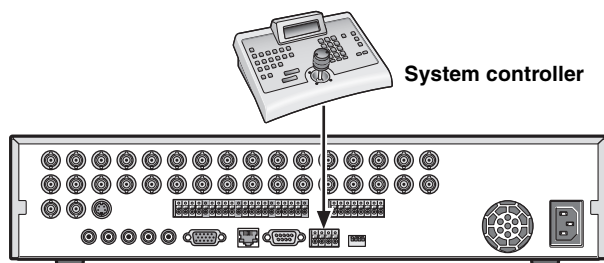

- Memo:**
- The setting of the RS-485 screen on the system setting is necessary when a system controller is connected. (P40)
 - Refer to the System controller's instruction manual for more information about the operation method.

If a camera is connected

If a PTZ dome camera equipped with a RS-485 control terminal is connected, the camera can be directly operated through this unit.

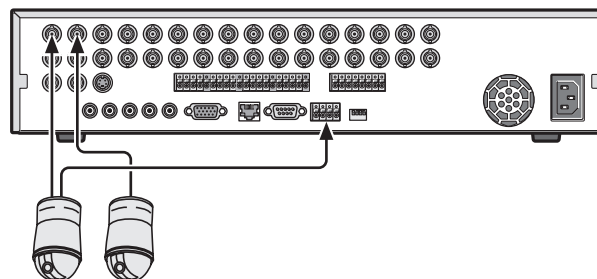

- Memo:**
- The settings on the PTZ CONTROL screen and RS-485 SET screen in the system setting are necessary when a camera is connected. (P14, 40)
 - Connection to the RS-485 control terminal is unnecessary for coaxial superimposed type (COAX) cameras. Select a protocol for COAX in the PTZ CONTROL settings. (P14)

Switching the power on / off

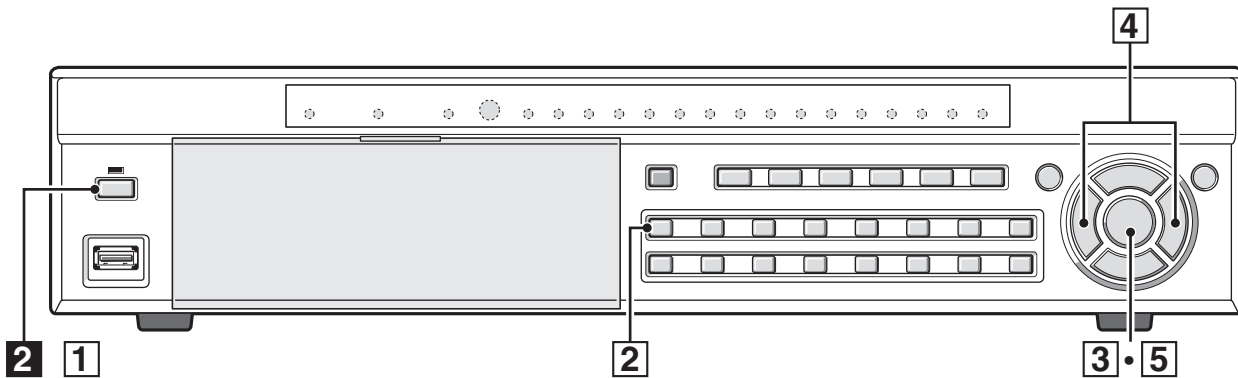

A Switching the power on

- 1** **Connect the power cable to the outlet.**
Turn on the electricity, the power indicator lights in orange (standby).
- 2** **Press the power button.**
The power indicator changes to green (running) and initialization starts.
During initialization the message "INITIALIZING..." and the firmware version are displayed on a "SANYO" logo screen.
Once the initialization is complete, live videos are displayed on multi-16 screen.



C CH1	NO VIDEO CH2	NO VIDEO CH3	NO VIDEO CH4
NO VIDEO CH5	NO VIDEO CH6	NO VIDEO CH7	NO VIDEO CH8
NO VIDEO CH9	NO VIDEO CH10	NO VIDEO CH11	NO VIDEO CH12
NO VIDEO CH13	NO VIDEO CH14	NO VIDEO CH15	NO VIDEO CH16

Do not press the power button during initialization. This may result in data loss.

B Switching the power off

- 1** **Press the power button.**
The password entering screen is displayed.
- 2** **Enter the ADMIN PASSWORD using the channel selection buttons.**
The factory default password is "1111".
For security reasons, make sure you change the default ADMIN PASSWORD. (P38)

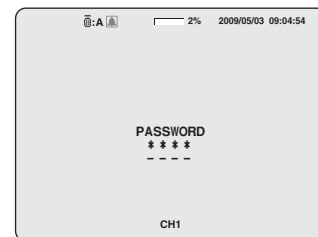

- 3** **Press the ENTER button.**
The SHUTDOWN confirmation screen is displayed.



- 4** **Select "CONFIRM" with the control button (<>).**

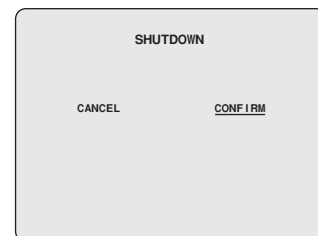
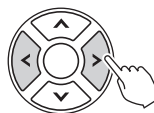

- 5** **Press the ENTER button.**
The power shuts down and the power indicator turns orange.



Pre-operation preparation

Screen display

Upon turning the power on, live video is displayed in the multi screen format.

- The screen display can be hidden except for the recording screen display. (P31)

■ Example of multi-16 screen

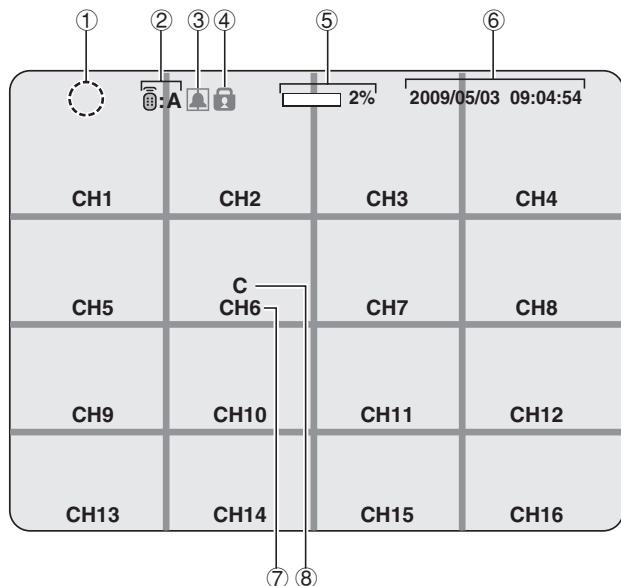

■ Example of single-screen

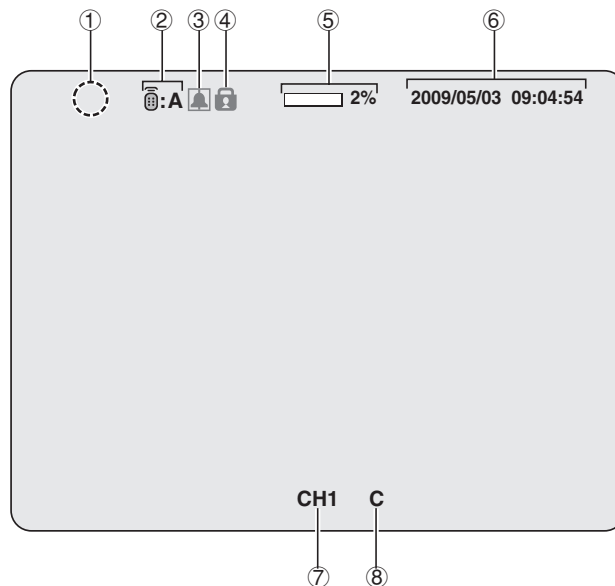

① Operation display

- : Displayed during live video sequencing.
- : Displayed during alarm output.
- : Displayed when the alarm output is set to DISABLE.
- : Displayed during remote operation by PC.

② Remote control display (P41)

- : Displays the remote control ID currently in operation.
If no remote ID is set the message "A(all)" is displayed.

③ Alarm input display

- : Turns red during an alarm recording triggered by motion or external alarm input (ALARM IN).

④ Security lock display

- : Displayed when setting the security lock. (P28)

⑤ Hard disk used capacity display

Displays the amount of recording on the hard disk from 0-99%. When the disk is full, "99%" changes to "FULL". When the recording setting is set to overwriting and the hard disk is full, to the left of the capacity display lights to indicate that the unit is in the overwriting mode.

⑥ Date and time display

This unit manages the recorded videos according to their date and time. Make sure the correct date and time are set in the CLOCK SET. (P9)

⑦ Camera channel display

Select display/hide channel in "OSD" in "LIVE settings". (P31)

⑧ Recording display

Factory default settings start continuous recordings (C) automatically once the power is turned on. Change the recording mode using the menu settings. (P35)

C: Recording in the continuous mode (CONTINUOUS)

R: Recording in the real time mode (When pressing the REC/STOP button)

M: Recording in the motion detection mode (MOTION)

A: Recording in the ALARM IN detection mode (ALARM)



- If a live video is disconnected, the message "VIDEO LOSS" is displayed on the monitor.
- If a video signal is not connected to the video input terminal, the message "NO VIDEO" is displayed on the monitor.

Pre-operation preparation

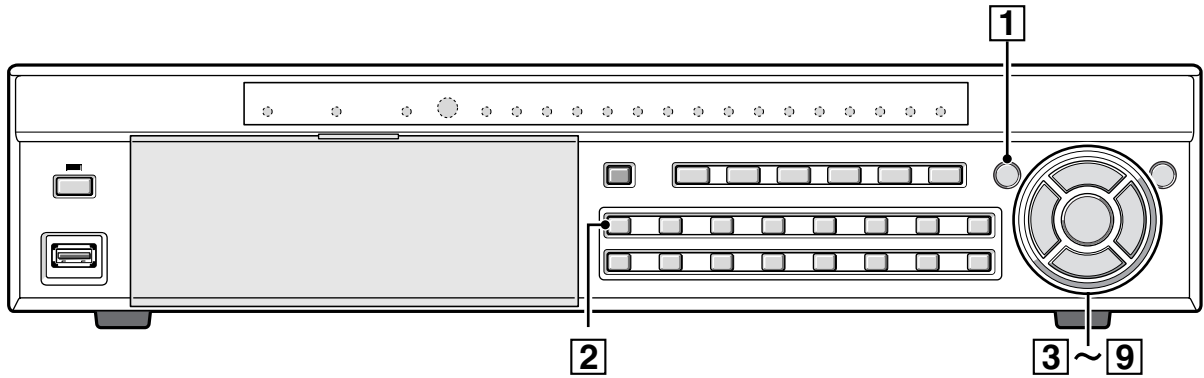

A Setting the television system and the monitor output

If the television system of the camera to be connected and the type of monitor differ, live videos cannot be monitored on the normal screen. Check the specifications of the equipment to be connected and set the system changeover switch on the rear panel.

- Do not forget to turn off the power when adjusting the settings.

■ Matching the television system of the camera (PAL)

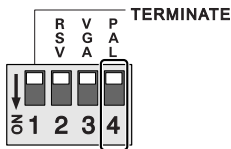

Up: When using a NTSC camera

Down: When using a PAL camera

Cannot be used when PAL and NTSC system are mixed.

■ Selecting the type of monitor (VGA)

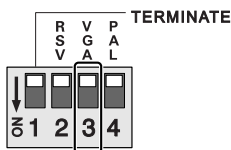

Up: When connecting the general monitor to the video output terminal

Down: When connecting a PC monitor to the VGA terminal

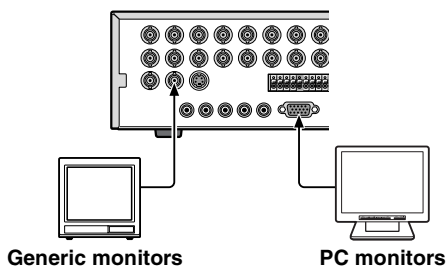

The VGA terminal and the video output terminal cannot be used simultaneously.

B Setting the clock (CLOCK SET)

- 1 Press the MENU button.
The PASSWORD input screen is displayed.

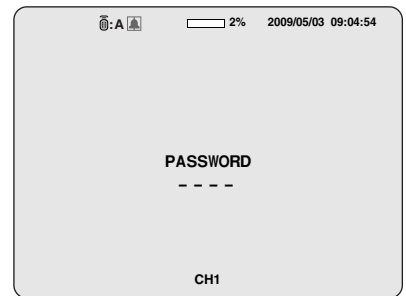

- To return to the previous screen, press the EXIT/ STOP button.

- 2 Enter the "ADMIN PASSWORD" using the channel selection buttons.

The MAIN MENU screen is displayed.

- "1111" is the factory default setting password.

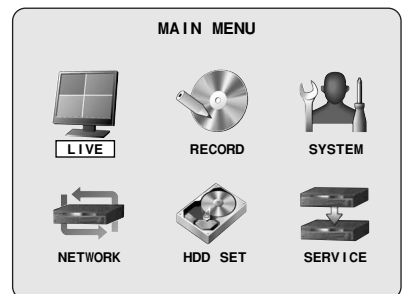
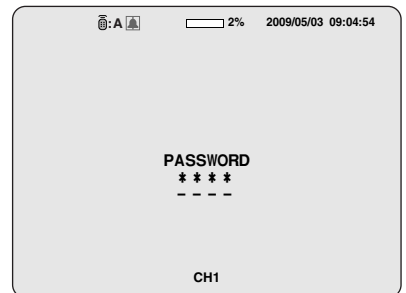
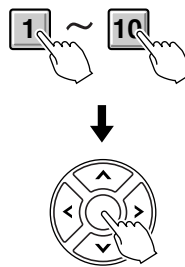

Pre-operation preparation

B

3 Press the control button (>) twice and select the "SYSTEM", press the ENTER button.

The SYSTEM settings screen is displayed.

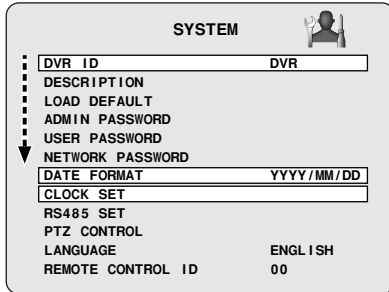

4 Select "DATE FORMAT" using the control button (▲▼) and select the date display format using the control button (<>).

- YYYY/MM/DD (Example: 2009/03/15)
- MM/DD/YYYY
- DD/MM/YYYY
- YYYY-MM-DD (Example: 2009-03-15)
- MM-DD-YYYY
- DD-MM-YYYY

5 Select "CLOCK SET" using the control button (▲▼) and press the ENTER button.

The CLOCK SET screen is displayed.

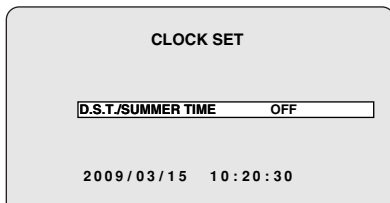

6 Select "D.S.T./SUMMER TIME" using the control button (▲▼), select the appropriate daytime saving time zone using the control button (<>).

If choosing EU or OTHERS set the applicable conditions.

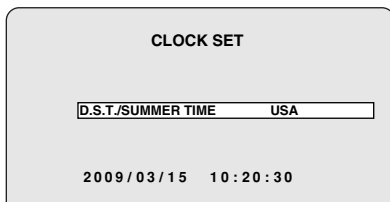

- **OFF**
Daylight saving is not set.
- **USA**
Applies the USA daylight saving time.
- **EU**
Applies the EU daylight saving time.

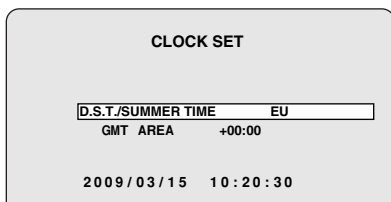

- ① Select the "GMT AREA" using the control button (▲▼).
- ② Set the time difference with the standard time using the control button (<>).

• **OTHERS**

If the time zone is neither USA nor EU, set the start and end date of the daylight saving period.

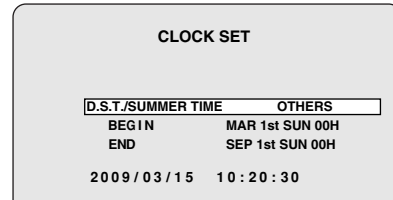

- ① Select "BEGIN" using the control button (▲▼) and press the ENTER button.
- ② Select the item using the control button (<>), select the setting value using the control button (▲▼).
- ③ Press the ENTER button once the daylight saving start date is set.
- ④ Set the daylight saving end date using the same procedure.

7 Select the display date and time using the control button (▲▼).

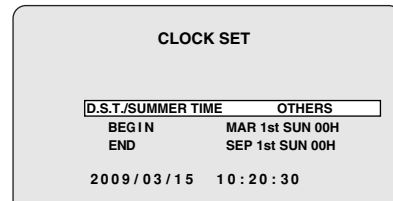

8 Select the item using the control button (<>), set the date and time using the control button (▲▼) and press the ENTER button.

The update time confirmation screen is displayed. After you confirm the screen, select "CANCEL" or "CONFIRM" using control button.

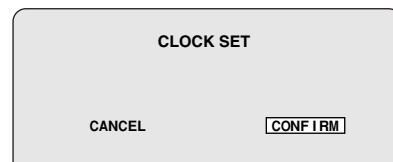

The date and time displayed on the update time confirmation screen takes daylight saving into consideration.

Pre-operation preparation

B

- 9 Select "CONFIRM" using the control button (<>) and press the ENTER button.

The unit automatically restarts, the initializing screen is displayed.

Once the initialization is complete and the live screen is displayed, the displayed date and time are updated.

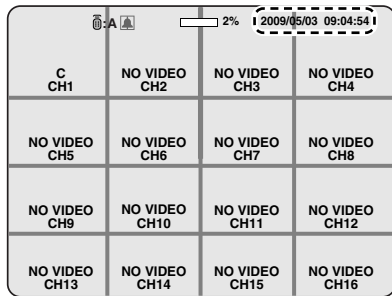

Correcting the set time

When a new time earlier than the previous recording time is set, the recording data that will be erased, showed in range (A), is displayed on the clock update confirmation screen. Confirm the time before selecting "CONFIRM" as any video data recorded after the set time will be erased.

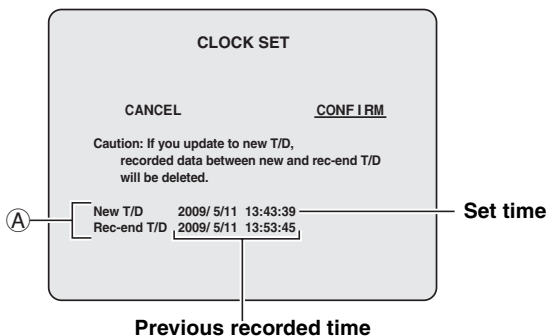

C

Setting the language (LANGUAGE)

- 1 Follow steps 1 to 3 of the CLOCK SET procedure.
- 2 Select "LANGUAGE" using the control button (▲▼) and select the display language using the control button (<>).

Once a language has been selected the display language changes.

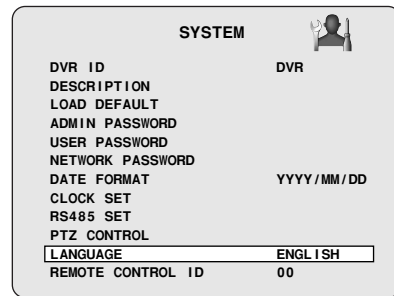

Language selection:

ENGLISH、日本語、DEUTSCH、Français、ESPAÑOL、ITALIANO、Русский язык、中文(繁體)、POLSKI、CESKY、Тългарски език、Romana、Srpski、SVENSKA、ภาษาไทย、INGLES

D

Setting the RS-485 termination switch (SANYO SSP side)

If multiple devices are connected terminator settings are necessary at both ends.

- When multiple devices are connected, make the termination switch "ON" on the first and last device you connected.
- When multiple devices are connected, make the termination switch "OFF" except the first and last devices that you connected.



If the termination switch is not set, the correct data will not be delivered to each unit.

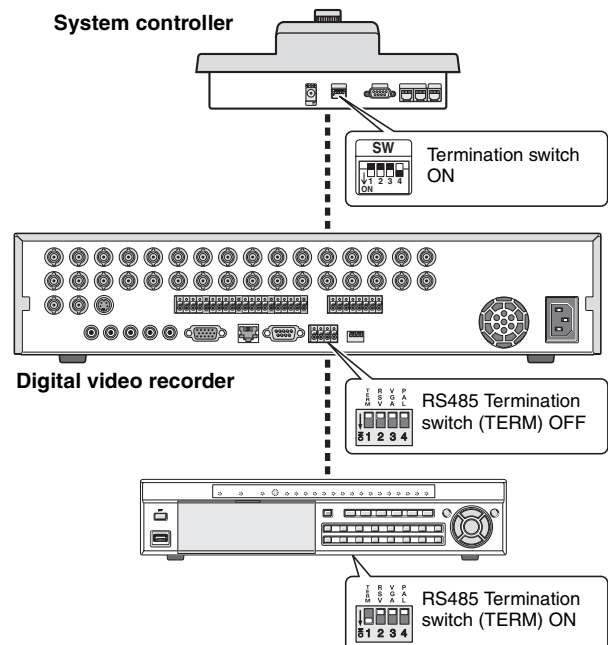

Monitoring the camera videos

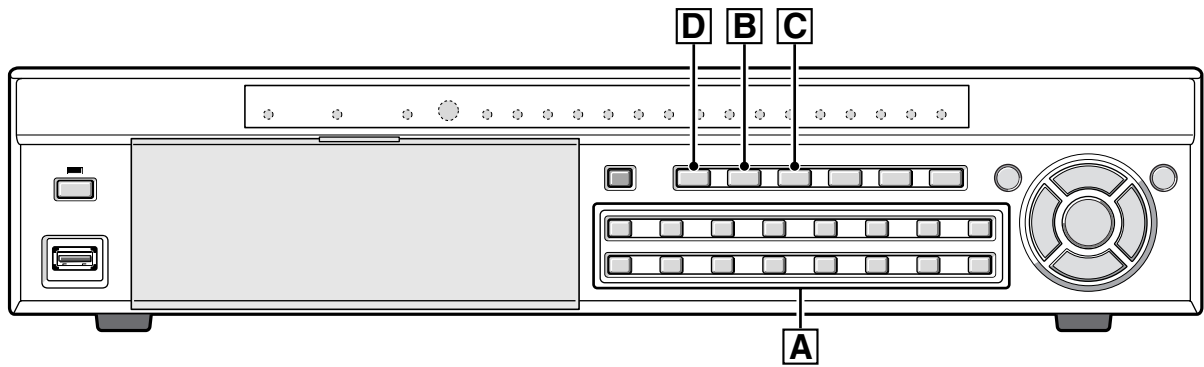

A Single-screen display

Displays the video of the camera specified using the channel selection button on single-screen.

Example: Displaying camera 2 on single-screen

Press "2" on the camera selection button.

The video of camera 2 is displayed on single-screen.

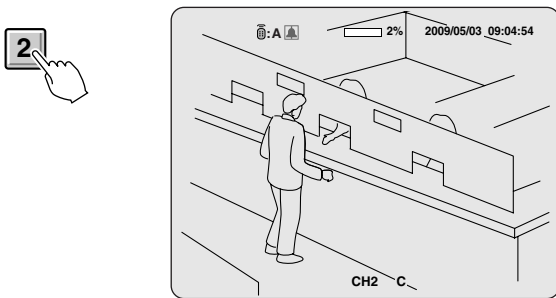

B Quad-screen display

Displays the 4 cameras video connected at once.

1 Press the QUAD button.

The videos of cameras 1 - 4 are displayed on quad-screen.

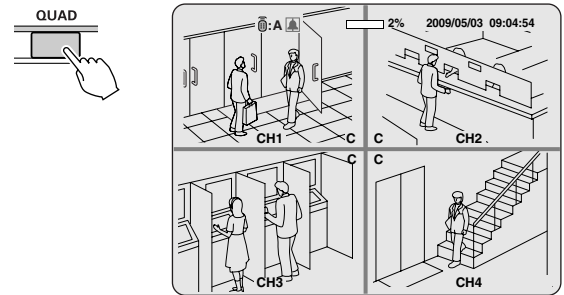

2 Press the QUAD button again.

The videos of cameras 5-8 are displayed on quad-screen.

Each time pressing the QUAD button, the video of the camera changes as the quad-screen.

DSR-2116

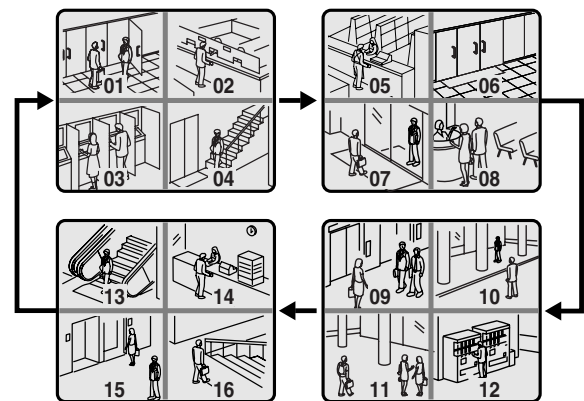

DSR-2108

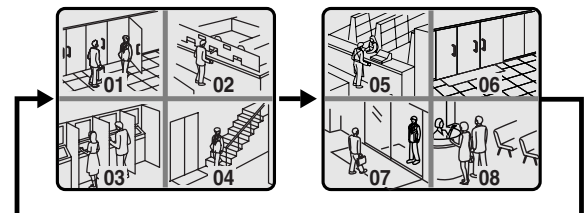

Monitoring the camera videos

C Multi-screen display

Displays the videos of 16 or 9 cameras simultaneously.

1 Press the MULTI button.

The videos of camera 1 - 16 are displayed on a multi-16 screen.

☞ In DSR-2108, the only available multi-screen is multi-8 screen.

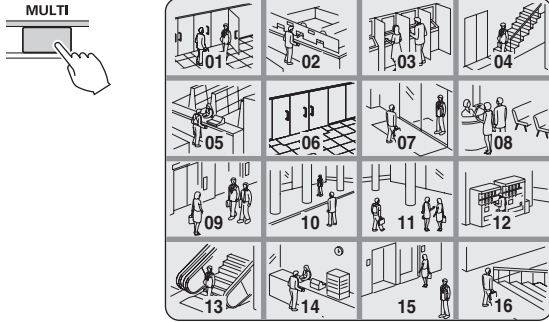

2 Press the MULTI button again.

The screen switches to a multi-9 screen, the videos of camera 1 - 9 are displayed.

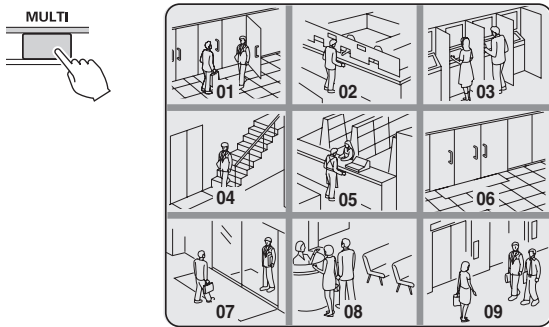

Pressing the button again switches the screen in turn from a multi-9 screen (2 patterns) to a multi-16 screen.

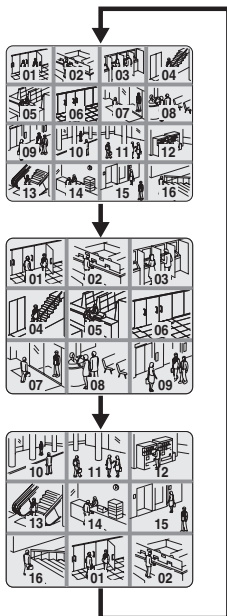

D Camera sequencing

Automatically displays the channel in sequence on a single or quad-screen.

1 Press the SEQ button while using the single or quad-screen display.

The cameras automatically switch in sequence starting with the channel of the camera being displayed. If there is an audio input, the audio also switches in channel sequence order.

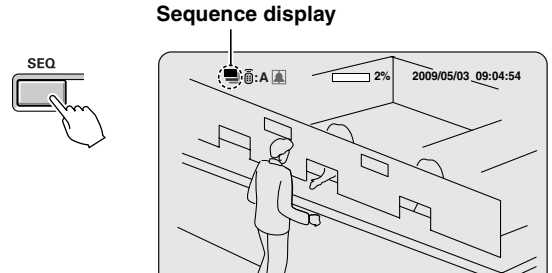

• When using single-screen display

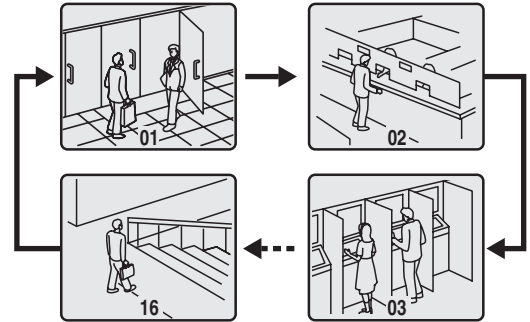

☞ In DSR-2108, single screens 1 to 8 are displayed in sequence.

• When using quad-screen display

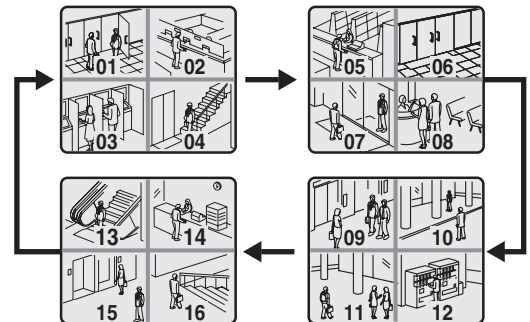

☞ In DSR-2108, the unit of 4 screens, 1 to 4 and 5 to 8, are displayed in sequence.

Memo:

- The sequence interval from one camera video to another can be set. (P31)
- Automatic camera sequencing is not available when using multi-8, multi-9, or multi-16 screen.

2 Press the SEQ button once operations are complete.

The sequence mode is cancelled.



Operating the PTZ dome camera

Pan/Tilt, Zoom/Focus operations are possible from this unit when a coaxial superimposed type (COAX) camera is connected, or a PTZ dome camera is connected using the RS-485 control terminal. Operation may not be possible depending on the connected camera.

1 Connection

When connecting other than a coaxial superimposed type (COAX) camera, connect the RS-485 control terminal of this unit and that of the camera using a twisted pair cable. Refer to "Connecting the RS-485 control terminal (P6)".

2 Settings

- 1 Press the MENU button (the MAIN MENU is displayed) and select "SYSTEM" using the control button (<>).

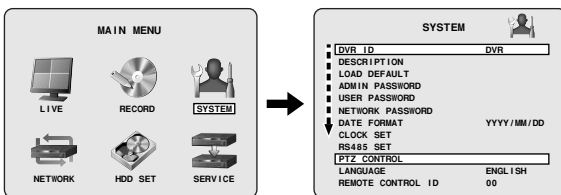

- A password is requested when pressing the MENU button. Enter the ADMIN PASSWORD. (P38)

- 2 Place the cursor on "PTZ CONTROL" and press the ENTER button.

The PTZ screen is displayed.

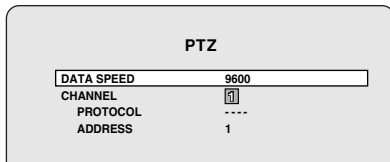

- 3 Point the cursor to "DATA SPEED" and set the communication speed.

The set speed is applied to all channels except for SANYO protocol.

Set the communication speed for the SANYO protocol using RS485 SET. (P40)

- 4 Point the cursor to "CHANNEL", specify the channel and set the "PROTOCOL" and "ADDRESS".

PROTOCOL: Selecting the type of protocol

ADDRESS: Camera ID (0 - 63)



When connecting multiple cameras to the RS-485 control terminal, set the same protocol for all cameras except for those cameras connected with SANYO protocol.

- 5 Press the EXIT/STOP button once the settings are complete.

3 Operation

- 1 Select the number of the PTZ dome camera connected using the camera selection button.

- 2 Press the PTZ button. The control screen is displayed.

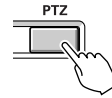

- 3 Controlling the camera

Control functions available differ according to the camera model.

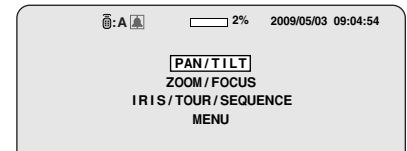
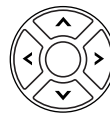

■ Pan/Tilt operations

- 1 Select "PAN/TILT" using the control button (▲▼) and press the ENTER button.
- 2 Adjust the tilt position using the control button (▲▼) and adjust the pan position using the control button (<>).
- 3 To perform automatic panning press the ENTER button.
 - The following message is displayed on the screen.
 - Up/Down key:** Tilt Up/Down
 - Left/Right key:** Pan Left/Right
 - Enter key:** Auto Pan

■ Zoom/Focus operations

- 1 Select "ZOOM/FOCUS" using the control button (▲▼) and press the ENTER button.
- 2 Adjust the zoom using the control button (▲▼) and adjust the focus position using the control button (<>).
- 3 To activate the auto focus press the ENTER button.
 - The following message is displayed on the screen.
 - Up/Down key:** Zoom In/Out
 - Left/Right key:** Focus Near/Far
 - Enter key:** Auto Focus

Operating the PTZ dome camera

3

■ Iris/Tour/Sequence operations

- ① Select "**IRIS/TOUR/SEQUENCE**" using the control button (**▲▼**) and press the ENTER button.
 - ② To perform tour operations press the control button (**▲**), to stop tour operations press the ENTER button.
 - ③ To perform sequence operations press the control button (**▼**), to stop sequence operations press the ENTER button.
 - ④ Adjust the aperture using the control button (**<>**).
- The following message is displayed on the screen.

Up/Down key: Tour ON/Sequence ON

Left/Right key: Iris Close/Open

Enter key: Tour/Sequence OFF

■ Camera menu settings

- ① Select "**MENU**" using the control button (**▲▼**) and press the ENTER button.
 - ② Select a menu using the control button (**▲▼**) and select a setting value using the control button (**<>**).
 - ③ To switch to the next screen or validate a setting value press the ENTER button.
- The following message is displayed on the screen.

Up/Down key: Cursor Up/Down

Left/Right key: Cursor Left/Right

Enter key: Enter

4 Press the EXIT/STOP button once operation are complete.



If no "PROTOCOL" is set on the PTZ screen, the following message is displayed on the screen.

"Please set up a camera type in setup menu."

Recording

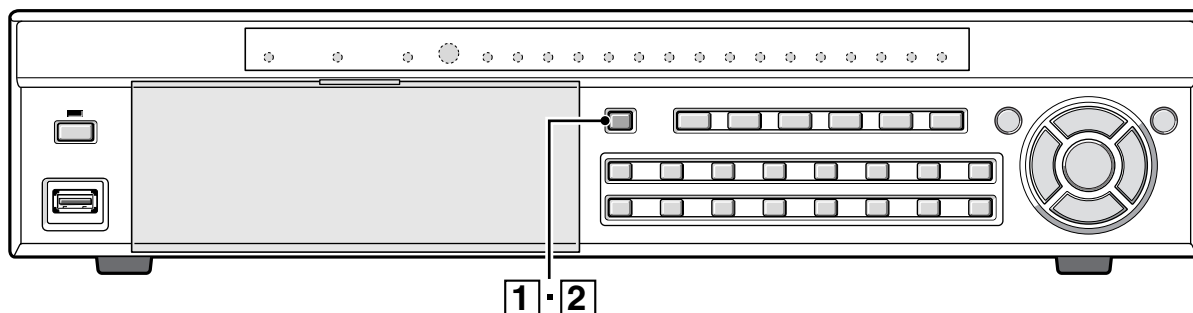

This unit allows the following recording modes.

Select the recording mode, recording resolution, frame rate and video quality from "RECORD" under the MAIN MENU. (P35)

The symbol on the right side of each recording mode (Ex: R) is displayed while recording is in progress.

Types of recording modes

A Real time recording (R) P16

Records manually videos being monitored.

B CONTINUOUS recording (C) P17

Records continuously when this unit is turned on.

C MOTION recording (M)..... P17

Records when set off by the motion sensor integrated in this unit.

D ALARM recording (A) P18

Records when set off by a sensor connected to the external alarm terminal (ALARM IN) of this unit.

E SCHEDULE recording..... P19

Records according to the daily time slot set under the TIMER SET screen of the recording settings.



- The initial screen requests a password. (P38)
- It is possible to cancel the password request. See "Settings for no password" (P38)

Memo: Setting the OVERWRITE (P47)

ON: Continues recording by overwriting earlier data even when the hard disk capacity is full.

OFF: Stops recording operations once the hard disk capacity is full.

A Real time recording

1 To manually start recording, press the REC/STOP button while monitoring live video.

"R" is displayed on the recording display and recording starts.

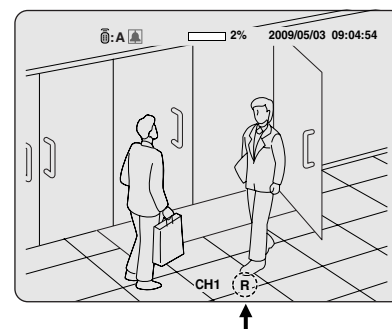

Memo: When operated manually, the unit records according to the settings for real time recording (REAL-TIME REC SET). (P36)

2 Press the REC/STOP button once operations are complete.

"R" disappears from the recording display and real time recording is stopped.



- When recording rate is high, the audio may be difficult to hear at the time of playback and playback time may increase.
- Recording time varies depending on the screen being recorded. Furthermore, recording rate may decrease depending on the settings.

Recording

B CONTINUOUS recording

1 Recording starts automatically when this unit is turned on.

"C" is displayed on the screen. The connected cameras are simultaneously recorded.

The recording mode can be changed using RECORDING under RECORD settings. Settings, such as image quality, can also be set. (P35)

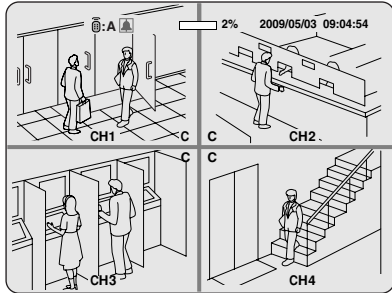

2 To stop recording, select "RECORDING" under RECORD settings using the control button (▲▼) and select "DISABLE" using the control button (<>). "C" disappears.

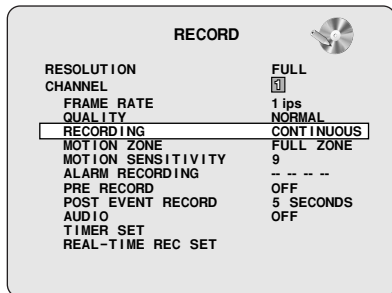

C MOTION recording

A motion sensor can be set for each channel.

1 Adjusting the following settings using the control button (▲▼<>).

- RESOLUTION
- CHANNEL
- FRAME RATE
- QUALITY

2 Select "RECORDING" using the control button (▲▼) and select "MOTION" using the control button (<>).

3 Select "MOTION ZONE" using the control button (▲▼) and select the "PARTIAL ZONE" using the control button (<>), press the ENTER button.

The motion setting screen is displayed.

- PARTIAL ZONE
- FULL ZONE



If "FULL ZONE" is selected, the motion setting screen is not displayed. Only set the level of sensitivity for MOTION SENSITIVITY.

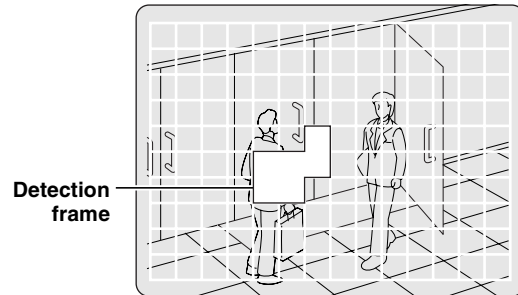
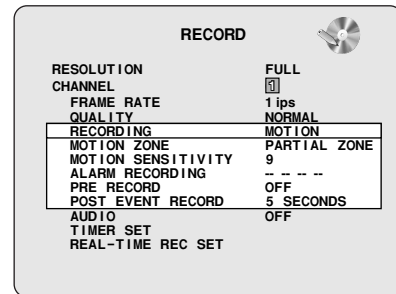

4 Select the sensor detection position using the control button (▲▼<>) and press the ENTER button.

The frame set for the sensor detection is grainy.

Select a sensor detection position by repeating the operation.

Once the setting of the event searched is complete, press the EXIT/STOP button to return to the RECORD screen.

5 Select "MOTION SENSITIVITY" using the control button (▲▼) and select the level of sensitivity using the control button (<>).

Selections: 1-9 (Low sensitivity)

6 Select "PRE RECORD" using the control button (▲▼) and select the pre recording as necessary using the control button (<>).

7 Select "POST EVENT RECORD" using the control button (▲▼) and select the recording time as necessary using the control button (<>).

Selections: 2 - 30 SECONDS, 1 - 5 MINUTES, 10 MINUTES, 15 MINUTES

8 Press the EXIT/STOP button once operations are complete.

Press the EXIT/STOP button repeatedly to return to the live video.

Recording

D ALARM recording

An external sensor can be connected to each channel.

1 Connecting an external switch to an external alarm input terminal.

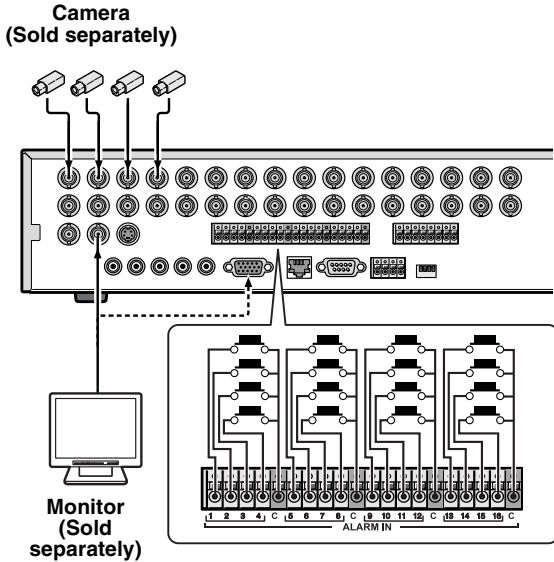

5 Select "PRE RECORD" using the control button (▲▼) and select the pre recording as necessary using the control button (<>).

6 Select "POST EVENT RECORD" using the control button (▲▼) and select the recording time as necessary using the control button (<>).

Selections: 2 to 30 SECONDS, 1 to 5 MINUTES, 10 MINUTES, 15 MINUTES

7 Press the EXIT/STOP button once operations are complete.

Press the EXIT/STOP button repeatedly to return to the live screen.

Memo: Set the alarm input conditions using "ALARM-SET" in LIVE settings. (P32)

2 Set the following items using the control button (▲▼<>).

- RESOLUTION
- FRAME RATE
- CHANNEL
- QUALITY

3 Select "RECORDING" using the control button (▲▼) and select "ALARM" using the control button (<>).

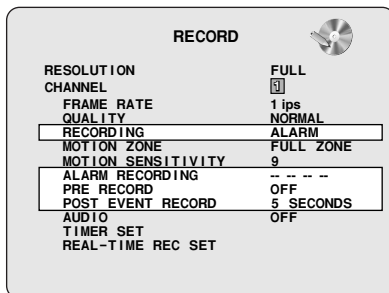

4 Select "ALARM RECORDING" using the control button (▲▼) and set the alarm input terminal number.

An ALARM recording is activated if there is an input in the specified external alarm input terminal.

Select a setting location (4 locations) using the control button (<>), and select an input terminal number using the control button (▲▼).

Recording

E SCHEDULE recording

1 Adjusting the following settings using the control button (▲▼<>).

- RESOLUTION
- CHANNEL
- FRAME RATE
- QUALITY

2 Select "RECORDING" using the control button (▲▼) and select "SCHEDULE" using the control button (<>).

 The following settings are necessary when performing sensor detection.

- MOTION ZONE
- MOTION SENSITIVITY
- PRE RECORD
- POST EVENT RECORD

3 Select "SCHEDULE" using the control button (▲▼) and press the ENTER button.

When the channel 1 is selected, "TIMER SET-CH1" screen is displayed.

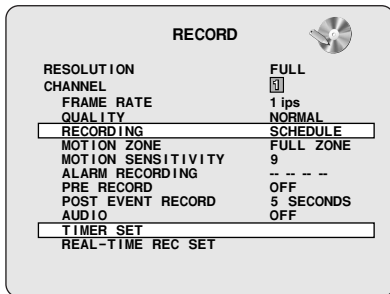

4 Select "ALL" or each day using the control button (▲▼) and set the recording mode using the ENTER button.

Repeat the procedure to set a different recording mode.

-: DISABLE (Does not record)

C: CONTINUOUS recording

M: MOTION recording

A: ALARM recording

Input example:

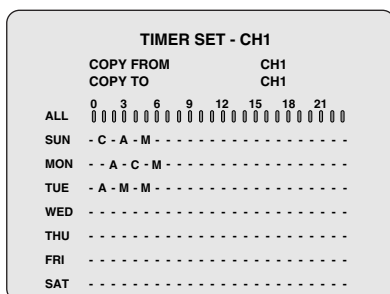

• Selecting an identical setting for every day (Example: CONTINUOUS):

Move the cursor to "ALL", the display turns red. Repeatedly pressing the ENTER button sets the same setting for every day.

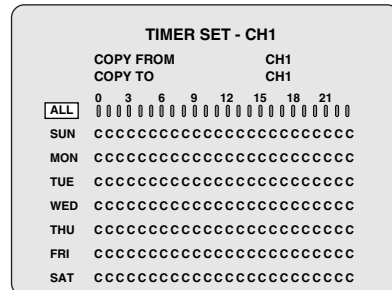

• Selecting the same setting for a whole day (Example: MOTION):

Move the cursor to the day, the display turns red. Repeatedly pressing the ENTER button sets the same setting for the whole day.

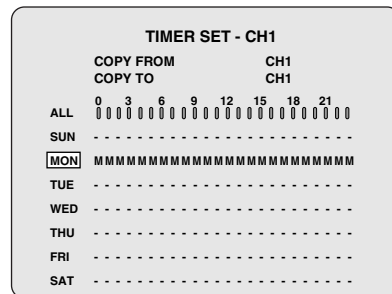

• Selecting the same setting for a specified time only every day (Example: MOTION):

Move the cursor to "ALL" and move the cursor to the specified time using the control button (>), the longitudinal bar changes to = (red). Press the ENTER button repeatedly to set the same setting (M).

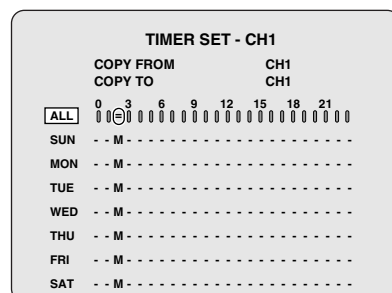

5 Press the EXIT/STOP button once operations are complete.

Press the EXIT/STOP button repeatedly to return to the live screen.

Playing back recorded videos

The following recorded videos searching methods are available.

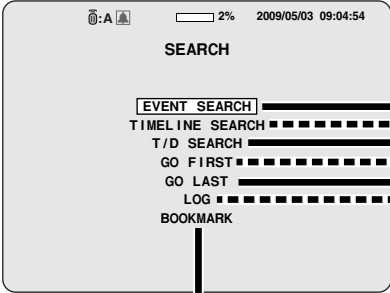

SEARCH

EVENT SEARCH

TIMELINE SEARCH

T/D SEARCH

GO FIRST

GO LAST

LOG

BOOKMARK

EVENT SEARCH (P22)

Search through a recorded video list by setting the date on the calendar display, the camera channel and specify the type of recording.

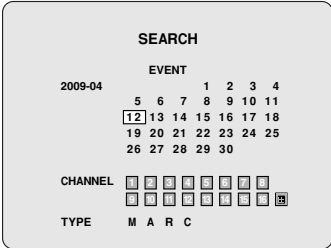

SEARCH

EVENT

2009-04

		1	2	3	4	
5	6	7	8	9	10	11
12	13	14	15	16	17	18
19	20	21	22	23	24	25
26	27	28	29	30		

CHANNEL

TYPE M A R C

TIMELINE SEARCH (P23)

Searching for an event by setting the date, time on the timeline.

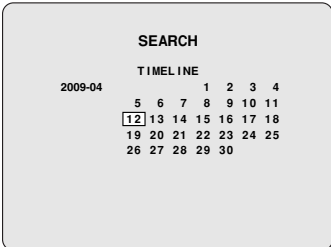

SEARCH

TIMELINE

2009-04

		1	2	3	4	
5	6	7	8	9	10	11
12	13	14	15	16	17	18
19	20	21	22	23	24	25
26	27	28	29	30		

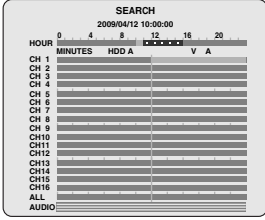

SEARCH

2009/04/12 10:00:00

HOUR	MINUTES	HDD A	V	A	
0	4	8	12	16	20
CH 1					
CH 2					
CH 3					
CH 4					
CH 5					
CH 6					
CH 7					
CH 8					
CH 9					
CH10					
CH11					
CH12					
CH13					
CH14					
CH15					
CH16					
ALL					
AUDIO					

BOOKMARK (P25)

Searches through the bookmarked still images or moving videos.

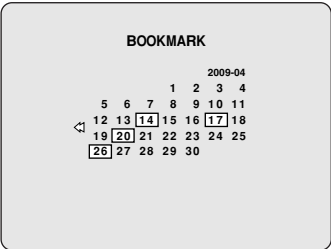

BOOKMARK

2009-04

		1	2	3	4	
5	6	7	8	9	10	11
12	13	14	15	16	17	18
19	20	21	22	23	24	25
26	27	28	29	30		

T/D SEARCH (P24)

Searching for an event by setting the date, time numerically.



SEARCH

2009/04/14 17:17:00

GO FIRST (P24)

Searching the first (oldest) recording data.

GO LAST (P24)

Searching the last (newest) recording data.

LOG (P24)

Viewing the operation / activities (LOG) of this unit on a specified date.

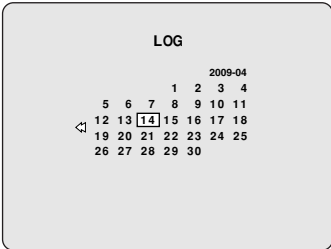

LOG

2009-04

		1	2	3	4	
5	6	7	8	9	10	11
12	13	14	15	16	17	18
19	20	21	22	23	24	25
26	27	28	29	30		



LIST

2009/04/14 (1/1)

03:28:37	System Start
08:02:55	System Start
08:04:20	Manual Record Start
08:04:35	Manual Record Stop
08:04:50	Manual Record Start
08:05:03	Manual Record Stop
08:05:34	Enter Setup
17:03:36	System Start
17:05:04	System Start
17:08:07	Manual Record Start
17:08:52	Manual Record Stop

The function of each button during playback.

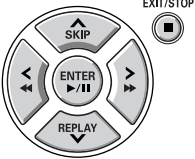

▶▶	The fast forward speed changes each time it is pressed, the symbol is displayed on the bottom right of the screen. ▶ (Standard) → 2▶▶ (X2) → 4▶▶ → 8▶▶ (Maximum x4 when playing back in multi-screen format)
◀◀	The fast rewind speed changes each time it is pressed, the symbol is displayed on the bottom right of the screen. ◀ (Standard) → 2◀◀ (X2) → 4◀◀ → 8◀◀ (Maximum x4 when playing back in multi-screen format)
SKIP	Jumps the video 1 minute forward
REPLAY	Jumps the video 1 minute backward
▶/II	Pause (Still image display) Press again to restart playback.
EXIT/STOP	Stops a playback in progress

Playback may be slow when the unit is establishing a network connection, or because of the recording conditions.

Playing back recorded videos

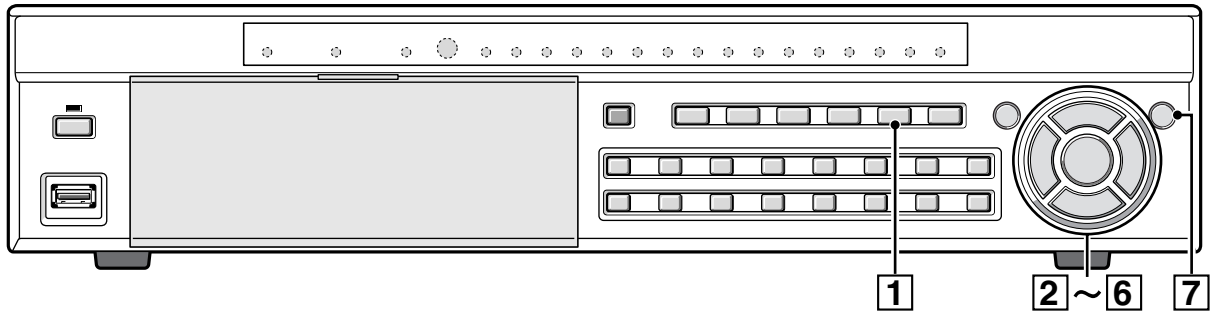

A EVENT SEARCH

- 1** Press the **SEARCH** button.
The menu screen is displayed.

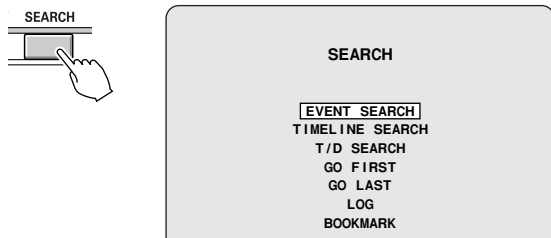

- 2** Select "EVENT SEARCH" using the control button (**▲▼**) and press the **ENTER** button.
The SEARCH screen is displayed.

- 3** Select the date you want to search using the control button (**▲▼<>**) and press the **ENTER** button.

- The cursor moves to CHANNEL.
- If recordings are available, the date is displayed in red.
 - ◀: Indicates that there are recordings in the previous month.
 - ▶: Indicates that there are recordings in the next month.
- Move the cursor to the day of the first recording in the month displayed by the calendar, pressing the **<** button displays the previous month of the calendar. Move the cursor to the day of the last recording in the month displayed by the calendar, pressing the **>** button displays the next months of the calendar.

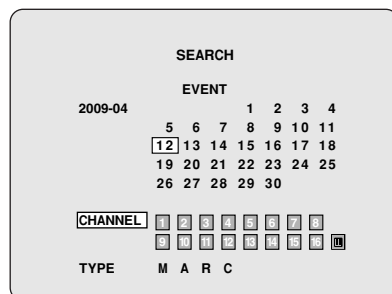

- 5** Select the type of recording (**M/A/R/C**) to be searched using the control button (**<>**) and press the **ENTER** button.

The selected type of recording is displayed in red. If the 4 letters are displayed in red, all the type of recordings have been selected.

- M:** Recording activated by motion detection (MOTION)
- A:** Recording activated by an external alarm input (ALARM)
- R:** Real time recording
- C:** Continuous recording (CONTINUOUS)

Example:

Searching recordings activated by the motion detection (M) of the channel 2 of the camera

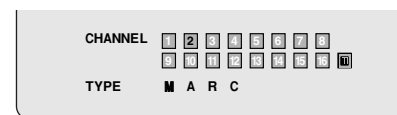

The list screen is displayed.

- 6** Select the videos to be played back using the control button (**▲▼**), and press the **ENTER** button.

Playback starts.
If the list continues on several pages, use the control button (**<>**) to change pages.

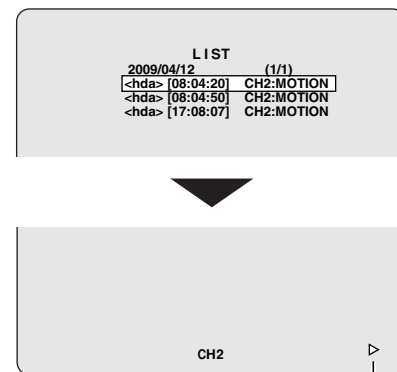

Playback in progress display

- 4** Select a channel with the control button (**<>**) and press the **ENTER** button.

- The cursor moves to TYPE.
- To select all the channels, select

- 7** Press the **EXIT/STOP** button once operations are complete.

Press the **EXIT/STOP** button repeatedly to return to the live screen.

Playing back recorded videos

B TIMELINE SEARCH

1 Press the SEARCH button.

The search menu screen is displayed.

2 Select "TIMELINE SEARCH" using the control button (▲▼) and press the ENTER button.

The SEARCH screen is displayed.

- If recordings are available, the date is displayed in red.

◀: Indicates that there are recordings in the previous month.

▶: Indicates that there are recordings in the next month.

Move the cursor to the day of the first recording in the month displayed by the calendar, pressing the ◀ button displays the previous month of the calendar. Move the cursor to the day of the last recording in the month displayed by the calendar, pressing the ▶ button displays the next months of the calendar.

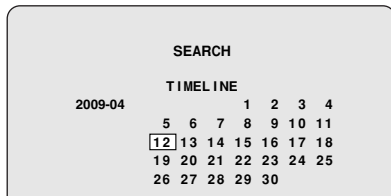

3 Select the date to be played back using the control button (▲▼◀▶) and press the ENTER button.

The timeline screen is displayed.

The recording information of the selected date is displayed in the timeline.

① HOUR scale

Displays 24 hours (1 hour x 24 marks).

Periods of recording are displayed using a blue timeline.

Move the yellow cursor left and right to display the MINUTES scale for the desired hour.

② MINUTES scale

Displays 1 hour (5 minutes x 12 marks).

The recording information of each channel for the period specified using the HOUR scale is displayed on the blue timeline.

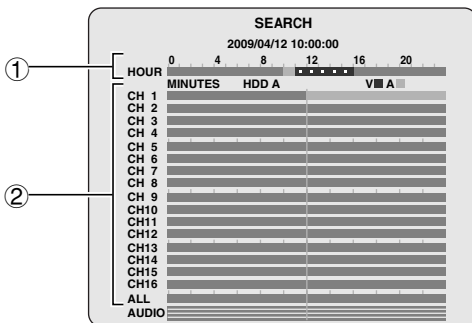

4 Move the yellow cursor of the HOUR scale to the specified period using the control button (▲▼) and press the ENTER button.

The HOUR scale cursor turns light blue and the timeline of the head channel of the MINUTES scale turns yellow.

5 Select the channel to be played using the control button (▲▼).

The timeline of the selected channel is displayed in yellow.

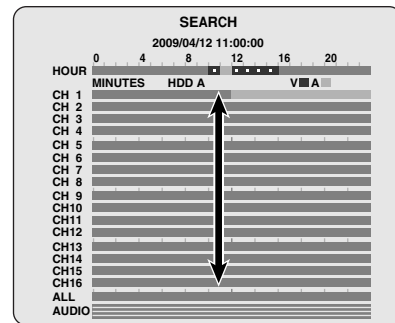

Memo: To play the video of all the channels simultaneously on a multi-16 screen select "ALL".

6 Move the vertical line (MINUTES scale) of the scale to the playback start point using the control buttons (◀▶) and press the ENTER button.

The recording starts playing from the specified point.

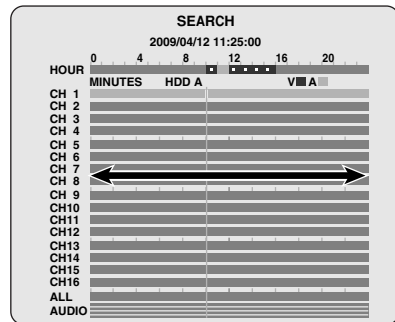

Memo: The vertical line (MINUTES scale) moves one minute at the time.

7 Press the EXIT/STOP button once operations are complete.

Press the EXIT/STOP button repeatedly to return to the live screen.

Memo: • Initially, the timeline of ALL is displayed in light blue.
• If there is an audio track, a timeline appears next to the bottom line "AUDIO".

Playing back recorded videos

C T/D SEARCH

- 1** Press the **SEARCH** button.
The search menu screen is displayed.
- 2** Select **"T/D SEARCH"** using the control button (**▲▼**) and press the **ENTER** button.
The **SEARCH** screen is displayed.
- 3** Select the date and time to be played back using the control button (**<>**) and input a value using the control button (**▲▼**).

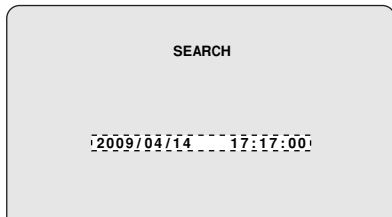

- 4** Press the **ENTER** button.
Playback starts.
 - When there is no video recorded on the specified date, playback may not start.
- 5** Press the **EXIT/STOP** button once operations are complete.
Press the **EXIT/STOP** button repeatedly to return to the live screen.

D GO FIRST

- 1** Press the **SEARCH** button.
The menu screen is displayed.
- 2** Select **"GO FIRST"** using the control button (**▲▼**) and press the **ENTER** button.
The first recording is played back.
- 3** Press the **EXIT/STOP** button once operations are complete.
Press the **EXIT/STOP** button repeatedly to return to the live screen.

E GO LAST

- 1** Press the **SEARCH** button.
The menu screen is displayed.
- 2** Select **"GO LAST"** using the control button (**▲▼**) and press the **ENTER** button.
The last recording is played back.
- 3** Press the **EXIT/STOP** button once operations are complete.
Press the **EXIT/STOP** button repeatedly to return to the live screen.

F LOG

- 1** Press the **SEARCH** button.
The menu screen is displayed.
- 2** Select **"LOG"** using the control button (**▲▼**) and press the **ENTER** button.
The **LOG** screen is displayed.
 - If recordings are available, the date is displayed in red.
 - ◀: Indicates that there are recordings in the previous month.
 - ▶: Indicates that there are recordings in the next month.

Moving the cursor to the day of the first recording in the month displayed by the calendar and pressing the **<** button displays the previous month of the calendar. Moving the cursor to the day of the last recording in the month displayed by the calendar and pressing the **>** button displays the next months of the calendar.

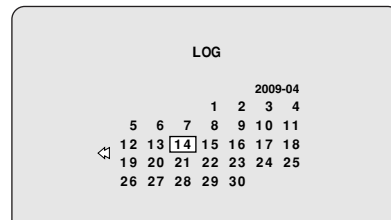

- 3** Select the date to be displayed using the control button (**▲▼<>**) and press the **ENTER** button.
The **LIST** screen is displayed.
 - If several lists are available, the previous or next **LIST** can be viewed using the control button (**<>**).

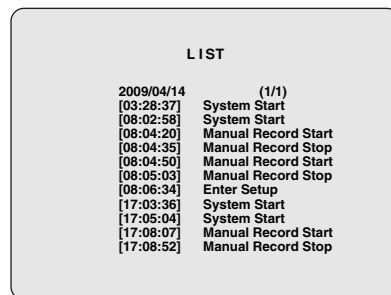

- 4** Press the **EXIT/STOP** button once operations are complete.
Press the **EXIT/STOP** button repeatedly to return to the live screen.

Playing back recorded videos

G BOOKMARK

Perform the mark operation of the desired live video.
The marked event can be selected and displayed from the list (date). (P26, 27)

1 Press the SEARCH button.

The menu is displayed.

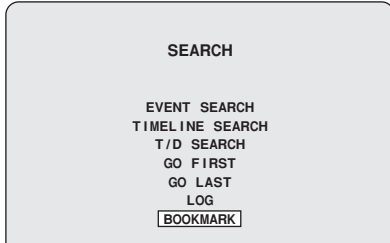

2 Select "BOOKMARK" using the control button (▲▼) and press the ENTER button.

The BOOKMARK screen is displayed.

- If bookmarks are available, the date is displayed in red.

◀: Indicates that there are bookmarks in the previous month.

▶: Indicates that there are bookmarks in the next month.

Moving the cursor to the day of the first bookmark in the month displayed by the calendar and pressing the < button displays the previous month of the calendar. Moving the cursor to the day of the last bookmark in the month displayed by the calendar and pressing the > button displays the next months of the calendar.

3 Select an event which date is displayed in red using the control button (▲▼<>) and press the ENTER button.

LIST is displayed.

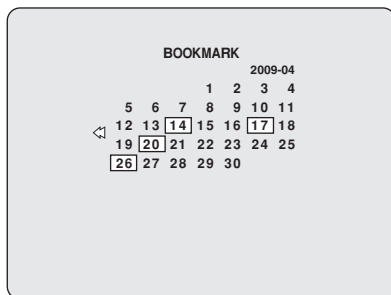

4 Select the date to be played back from the list using the control button (▲▼) and press the ENTER button.

The still image is displayed.

Copying recorded video to recording media

Necessary video can be selected and copied to USB memory or to a DVD-R, CD-R/RW.

A Inserting recording media

Insert the recording media (USB memory) in advance before you perform copy operation.

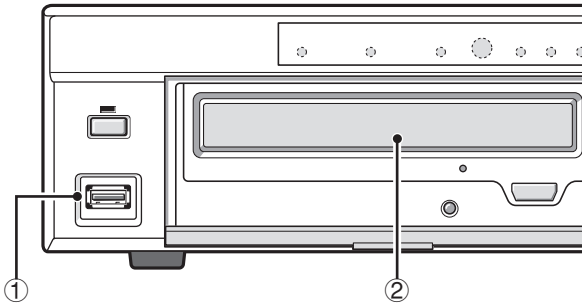

① To copy onto a USB memory

Connect a USB memory to the USB terminal on the front panel.

② To copy onto a DVD-R, CD-R/RW

To open and close the insert tray, open the panel of the disk drive and press the button.



- **DVD-R, CD-R:**
Use new discs.
- **CD-RW:**
If there is data previously written on the disc, use Windows Explorer to erase the data.

B Copying live videos

1 Press the MARK/COPY button at the scene to be copied while monitoring live videos.

The copy screen is displayed after the "BOOKMARK OK" message.

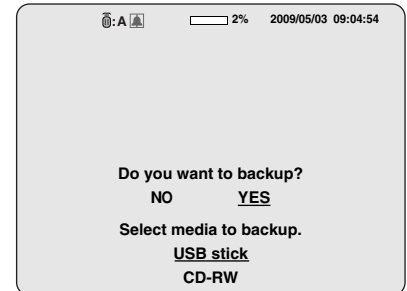

2 In response to the confirmation message (Do you want to backup?) select "YES" using the control button (<>).

Memo: Regardless of whether "YES/NO" is selected, images are marked and recorded from the point when the MARK/COPY button is pressed. Search/display of marked still image can be performed using BOOKMARK in the search menu. (P25)

3 Select the recording media (USB stick or CD-RW) onto which the video should be copied using the control button (▲▼) and press the ENTER button.

The message "SAVING..." is displayed and copying starts.

When copying is complete the message "SAVE SUCCESS" is displayed.

Memo: If the specified recording media has not been inserted, an error message is displayed depending on the type or state of the inserted media.

4 Press the EXIT/STOP button once operations are complete.

Press the EXIT/STOP button repeatedly to return to the live screen.

Copying recorded video to recording media

C Copying a playback video

The image to be copied can be selected on still and moving images.

- 1 While playing back the recorded video press the **MARK/COPY** button at the scene to be copied.

The video is paused and the **BOOKMARK** screen is displayed.

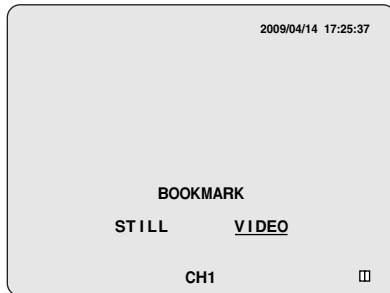

- 2 Select the copy mode (**STILL** or **VIDEO**) using the control button (**<>**) and press the **ENTER** button.

- **STILL:**
Copies still images.
Pressing the **ENTER** button displays the copy screen. (go to step 5)
- **VIDEO:**
Copies moving images.
Pressing the **ENTER** button displays the **DURATION** screen. (go to step 3)

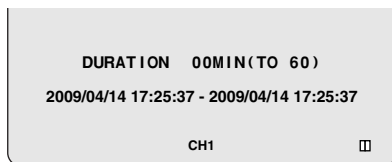

- 3 Select the channel to be copied using the channel selection button (**1 - 16**).

In **DSR-2108**, channel selection buttons are **1 to 8**. The colour of the corresponding channel indicator changes alternatively each time a channel selection button is pressed.

- **Yellow:** Copy enabled
- **White:** Copy disabled

Memo: The images of channels indicated in yellow are sequentially copied to the recording media.

- 4 Specify the hour (minutes) to be saved using the control buttons (**▲▼<>**) and press the **ENTER** button.

The copy screen is displayed.

Memo: Select a digit using the control button (**<>**) and select a value using the control button (**▲▼**). Up to a maximum of 60 minutes can be selected when using minutes as a unit.

- 5 In response to the confirmation message (**Do you want to backup?**) select **"YES"** using the control button (**<>**).

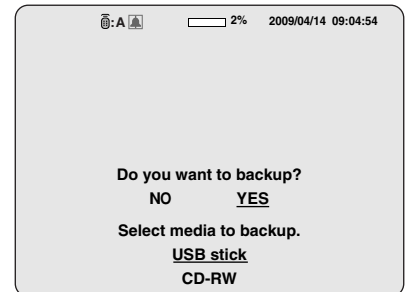

Memo: If **"YES"** is selected, the image at the point where the **MARK/COPY** button is pressed is marked and recorded. Search/display of marked still image can be performed using **BOOKMARK** in the search menu. (P25)

- 6 Select the recording media (**USB stick** or **CD-RW**) onto which the video should be copied using the control button (**▲▼**) and press the **ENTER** button.

The message **"SAVING..."** is displayed and copying starts.

When copying is complete the message **"SAVE SUCCESS"** is displayed.

Memo: If the specified recording media has not been inserted, or there is a problem with the media type or state of the inserted media, an error message is displayed.

- 7 Press the **EXIT/STOP** button once operations are complete.

Press the **EXIT/STOP** button repeatedly to return to the live screen.

D Playing back copied videos

Still images are copied in a **JPG** format and video images are recorded in **AVI** format. Ensure that an image display software compatible with the **JPG** format is used to playback still images and a video imaging software compatible with the **AVI** format is used to playback video images.

Folder structure of copied videos

```

YYYYMMDD
Year | Day | Month | hhmmsscc.avi (Moving video file)
                                     | hhmmsscc.smi (Ancillary moving video
                                     | hhmmsscc.avi information file)
                                     | hhmmsscc.smi
                                     | Hour | Second | Minute | Channel
    
```

Memo: If the video cannot be played with standard video software, install **FFDShow** (Codec) from the supplied **CD-ROM**.

- To start the installer insert the **CD-ROM** in the drive of the **PC** and double-click on the **"ffdshowyyyymmdd.exe"** file.
- Follow the setup wizard and install using the initial settings for codec, filters, etc.

Setting the security lock

Setting a security lock locks all the operation buttons of this unit.

■ Setting a security lock

- 1** Press the EXIT/STOP button for approximately 5 seconds.

The password entering screen is displayed.

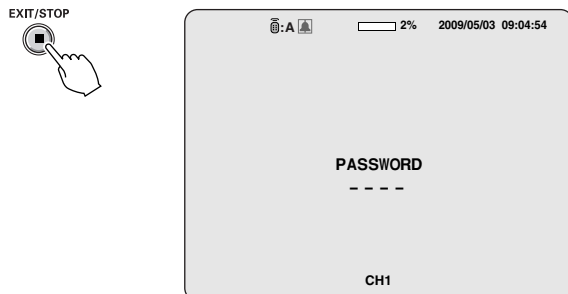

- 2** Enter the "ADMIN PASSWORD" using the channel selection buttons.

The factory default password is "1111".

- 3** Press the ENTER button.

The security lock is set and the blue security lock icon is displayed.

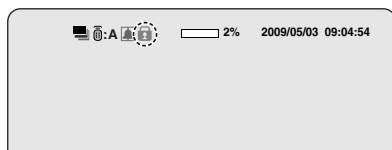

■ Canceling the security lock

- 1** Press the EXIT/STOP button for approximately 5 seconds.

The password entering screen is displayed.

- 2** Enter the "ADMIN PASSWORD" using the channel selection buttons.

- 3** Press the ENTER button.

The security lock is cancelled and the blue security lock icon disappears.

Configuration and function of the Menu settings

■ LIVE settings (P31)

To perform adjustments related to live videos monitoring such as sequencing settings and each camera video adjustments.

LIVE	
OSD	ON
SEQUENCE	ON
SEQUENCE-DWELL TIME	2 SECONDS
EVENT BEEP	OFF
OSD CONTRAST	90%
CHANNEL	CH1
DISPLAY	ON
BRIGHTNESS	50%
CONTRAST	50%
HUE	50%
SATURATION	50%
ALARM-SET	
MON2-OUT	

■ RECORD settings (P35)

To perform adjustments related to recordings such as resolution, the recording mode for each channel, video quality, motion and alarm settings.

RECORD	
RESOLUTION	FULL
CHANNEL	CH1
FRAME RATE	1fps
QUALITY	NORMAL
RECORDING	CONTINUOUS
MOTION ZONE	FULL ZONE
MOTION SENSITIVITY	9
ALARM RECORDING	---
PRE RECORD	OFF
POST EVENT RECORD	5 SECONDS
AUDIO	OFF
TIMER SET	
REAL-TIME REC SET	

■ SYSTEM settings (P37)

To perform settings carried out by the manager, such as setting initialization and password, date and time, language and PTZ CONTROL settings.

SYSTEM	
DVR ID	DVR
DESCRIPTION	
LOAD DEFAULT	
ADMIN PASSWORD	
USER PASSWORD	
NETWORK PASSWORD	
DATE FORMAT	MM/DD/YYYY
CLOCK SET	
RS485 SET	
PTZ CONTROL	
LANGUAGE	ENGLISH
REMOTE CONTROL ID	00

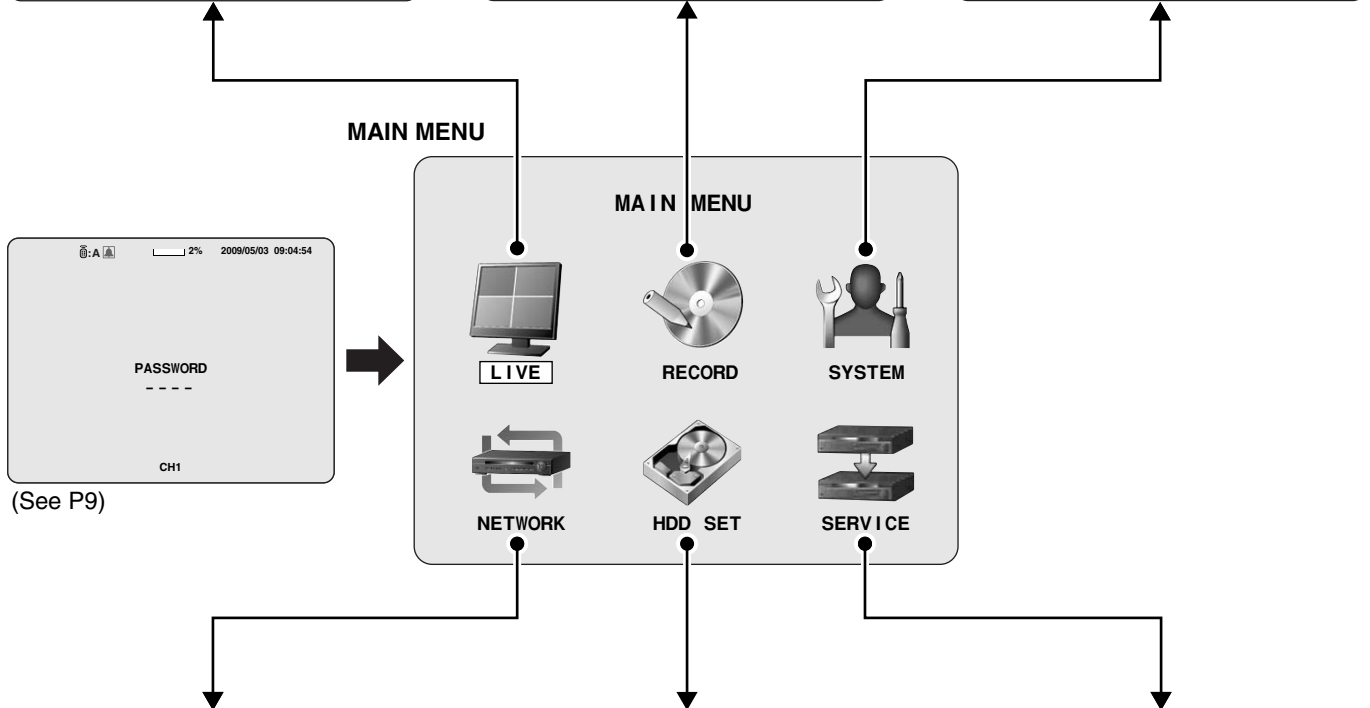

■ NETWORK settings (P42)

To perform remote operations by network and PC connection.

NETWORK	
PORT	5445
CLIENT ACCESS	ON
BANDWIDTH SAVING	ON
NETWORK TYPE	LAN
IP	0.0.0.0
SUBNET MASK	0.0.0.0
GATEWAY	0.0.0.0
DNS	0.0.0.0
DDNS	OFF
SEND E-MAIL	OFF
NTP SET	OFF

■ HDD SET settings (P47)

Settings related to the hard disk such as overwriting settings and initialization.

HDD SET	
OVERWRITE	ON
FORMAT	
AUTO DELETE	OFF
AUTO DELETE DAYS	30 DAYS

■ SERVICE settings (P49)

To perform such operations as saving the settings to the USB memory.

SERVICE	
SAVE SETUP TO A USB	
LOAD SETUP FROM A USB	
DISK INFO	

Configuration and function of the Menu settings

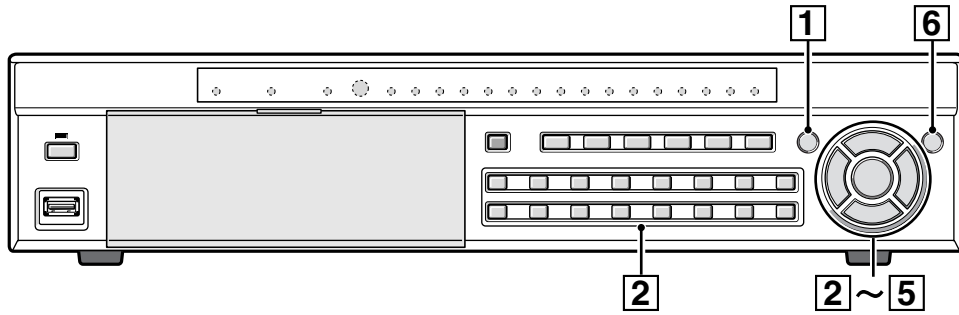

Basic operations of the MAIN MENU

- 1 Press the MENU button.**
The PASSWORD input screen is displayed.

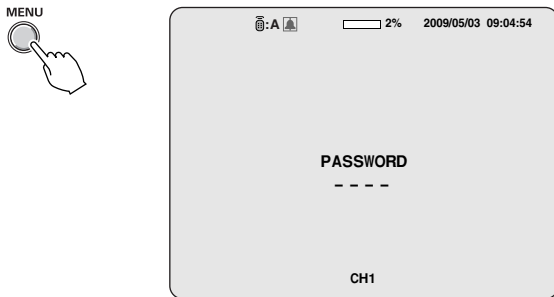

- 2 Input the "ADMIN PASSWORD" using the channel selection button and press the ENTER button.**
The MAIN MENU screen is displayed.
 - "1111" is the factory default setting password.

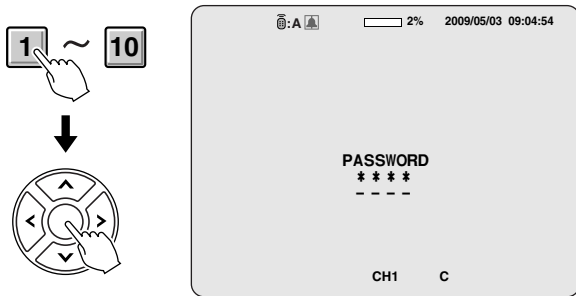

In DSR-2108, input using channel selection button 1 - 8.

- 3 Select the menu using the control button (▲▼<>).**
Example: RECORD

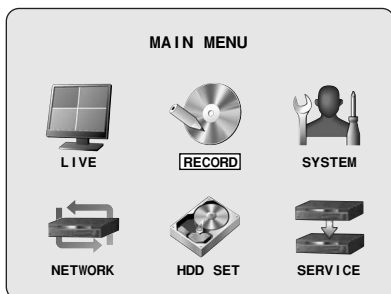

- 4 Press the ENTER button.**
The RECORD menu is displayed.

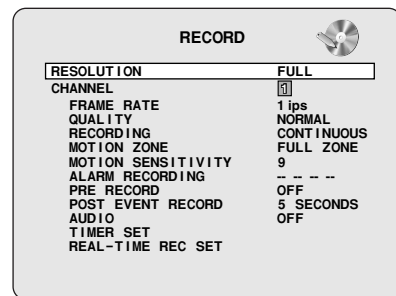

- 5 Select an item using the control button (▲▼) and set the details using the control button (<>).**
If a different screen is available for the settings, select the item, press the ENTER button and set the settings.

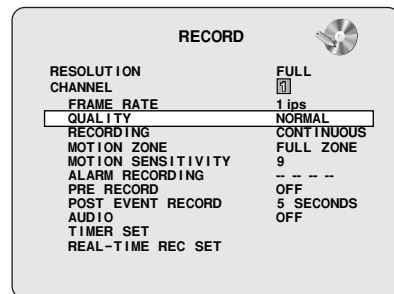

- 6 Press the EXIT/STOP button once operations are complete.**
Press the EXIT/STOP button repeatedly to return to the live screen.

Memo: The contents of the settings are saved when leaving the menu setting screen.

Even if the power is turned off the settings content are retained.

LIVE settings

Press the MENU button and enter the ADMIN PASSWORD. The MAIN MENU is displayed, select "LIVE" using the control button (▲▼<>).

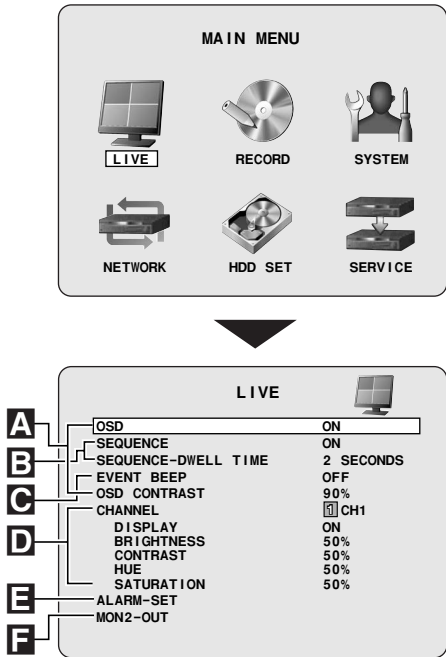

Function of the menu operation button

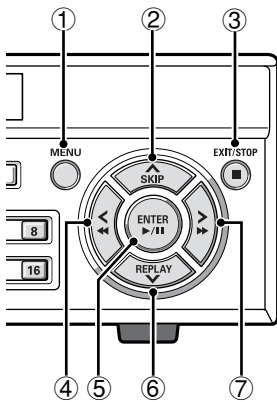

- ① **MENU:** The MAIN MENU is displayed once the password is input using the buttons.
- ② **▲:** Press to move the cursor upward.
- ③ **EXIT/STOP:** Press repeatedly once the menu operations are complete.
- ④ **<:** Press to select a setting value.
- ⑤ **ENTER:** Press to enter the setting screen, select and confirm.
- ⑥ **▼:** Press to move the cursor down.
- ⑦ **>:** Press to select a setting value.

A Setting the OSD and OSD CONTRAST

Displays information such as the date and camera channel and sets the character contrast on the screen.

- 1 Select "OSD" using the control button (▲▼) and select ON or OFF using the control button (<>).

ON: The date and time, as well as the channel, are displayed on the screen.

OFF: Characters and symbols are not displayed (At playback, date and time as well as channel are displayed even if set to OFF).

- 2 Select "OSD CONTRAST" using the control button (▲▼) and adjust the character contrast using the control button (<>).

The display bar (20 - 100 %) changes and the contrast of the real time character display changes.

B Setting the SEQUENCE and SEQUENCE-DWELL TIME

To set the sequence and the sequence interval of the screen.

- 1 Select "SEQUENCE" using the control button (▲▼) and select ON using the control button (<>).

ON: Sequencing is performed on a single or quad-screen (When live).

OFF: Sequencing is not performed.

- 2 Select "SEQUENCE-DWELL TIME" using the control button (▲▼) and select a sequence interval using the control button (<>).

Selections: 1, 2, 3 - 58, 59, 60 SECONDS

C Setting the EVENT BEEP

To set the alarm sound when motion recording or alarm recording is triggered.

Select "EVENT BEEP" using the control button (▲▼) and select ON or OFF using the control button (<>).

ON: The alarm sound is generated when an alarm is triggered.

OFF: The alarm sound is not triggered.

LIVE settings

D Setting a CHANNEL

To set the video settings on each channel.

Select an item for each setting using the control button (▲▼) and select a setting value using the control button (<>).

● Setting a CHANNEL and the channel designation

- 1 Select "CHANNEL" using the control button (▲▼) and select a channel from the following channels using the control button (<>), press the ENTER button.

Selections: CH1 - CH16

☞ In DSR-2108, CH1 - CH8.

The CHANNEL screen used for channel settings is displayed.

When not changing the designation of the channel, only select a channel.

- 2 Select the input position using the control button (▲▼) and select input characters using the control button (<>).

Character selection: (Refer to "DVR ID input display list": P80)

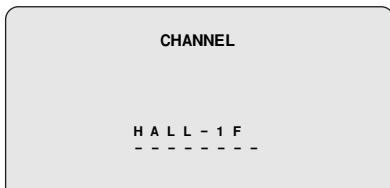

Press the EXIT/STOP button once operations are complete.

Changing the present CH1 display to HALL-1F (Example).

● Setting the DISPLAY

To select "DISPLAY", and set the screen display.

ON: Displays live videos

OFF: Does not display live videos

Memo: The display of screen information, such as time and date and channel, depends on the settings of the OSD. (P31)

● Setting the BRIGHTNESS

To select "BRIGHTNESS" and adjust the brightness of the videos.

The brightness of the video changes in real time.
(0 - 100 %)

● Setting the CONTRAST

To select "CONTRAST" and adjust optimally the dark parts and bright parts of the video.

The contrast of the image changes in real time.
(0 - 100 %)

● HUE settings

To select "HUE" and adjust the hue of the video.

The hue of the images changes in real time.
(0 - 100 %)

● Setting the SATURATION

To select "SATURATION" and adjust the saturation of the video.

The saturation of the images changes in real time.
(0 - 100 %)

Press the EXIT/STOP button once operations are complete.

Press the EXIT/STOP button repeatedly to return to the live screen.

E Alarm input output settings

Sets the alarm input/output conditions of the alarm input/output terminal.

- 1 Select "ALARM-SET" using the control button (▲▼) and press the ENTER button.

The ALARM-SET screen is displayed.

ALARM-SET	
ALARM OUT	ENABLE
ALARM OUT NO.	1
ALARM IN	- - - -
MOTION ON	- - - -
VIDEO LOSS ON	- - - -
HDD ERROR	OFF
ALARM DURATION	5 SEC
ALARM IN NO.	1
TYPE	- -

- 2 Select "ALARM OUT" using the control button (▲▼) and set whether or not an alarm signal should be output through this unit using the control button (<>).

ENABLE: An alarm signal is output.

DISABLE: No alarm signal is output.

- 3 Select "ALARM OUT NO." using the control button (▲▼) and specify the alarm output terminal number (1 - 4) using the control button (<>).

Sets the alarm output conditions of the specified alarm output terminal.

● Setting the ALARM IN

An alarm signal is output when the specified external alarm input terminal receives an input.

- 1 Select "ALARM IN" using the control button (▲▼).
- 2 Select the setting position (4 positions) using the control button (<>).
- 3 Select the input terminal number (1 - 16) using the control button (▲▼).
☞ In DSR-2108, input terminal number (1 - 8).
- 4 Press the ENTER button.

● Setting the MOTION ON

An alarm signal is output when the specified video input terminal receives a MOTION detection signal.

- 1 Select "MOTION ON" using the control button (▲▼).

LIVE settings

E

- ② Select the setting position (4 positions) using the control button (<>).
- ③ Select the input terminal number (1 - 16) using the control button (▲▼).
 - ☞ In DSR-2108, input terminal number (1 - 8).
- ④ Press the ENTER button.

● Setting the VIDEO LOSS ON

An alarm signal is output when the specified video input terminal receives a VIDEO LOSS occurs.

- ① Select "VIDEO LOSS ON" using the control button (▲▼).
- ② Select the setting position (4 positions) using the control button (<>).
- ③ Select the input terminal number (1 - 16) using the control button (<>).
 - ☞ In DSR-2108, input terminal number (1 - 8).
- ④ Press the ENTER button.

● Setting the HDD ERROR

An alarm signal is output when a hard disk error occurs.

- ① Select "HDD ERROR" using the control button (▲▼).
- ② Select output ON or OFF using the control button (<>).

● Setting the ALARM DURATION

Sets the duration of the alarm output signal.

- ① Select "ALARM DURATION" using the control button (▲▼).
- ② Select the output duration (3 - 255 seconds) using the control button (<>).

- 4 Select "ALARM IN NO." using the control button (▲▼) and specify the alarm input terminal number (1-16) using the control button (<>).
Setting the signal polarity of the specified alarm input terminal.

☞ In DSR-2108, input terminal number (1 - 8).

● Setting the TYPE

- ① Select "TYPE" using the control button (▲▼).
- ② Set the signal polarity using the control button (<>).
---: Does not react

N/OPEN (Normal Open):

Normally open, reacts when closed

N/CLOSE (Normal Close):

Normally closed, reacts when opened

F

Setting the MON2 (Monitor2)-OUT

Sets the output conditions of the monitor video terminal (MON2).

- 1 Select "MON2-OUT" using the control button (▲▼) and press the ENTER button.

The MON2-OUT screen is displayed.

MON2-OUT	
MON2 TYPE	FULL
MON2 ON EVENT	ON
MON2 EVENT DWELL TIME	10 SEC
SEQUENCE	OFF
SEQUENCE-DWELL TIME	10 SEC
MON2 CHANNEL	1

- 2 Setting the output conditions of the MON2 terminal

● Setting the MON2 TYPE

Sets the output screen layout of the MON2 terminal.

- ① Select "MON2 TYPE" using the control button (▲▼).
- ② Select the screen layout using the control button (<>).
FULL: Single-screen output
QUAD: Quad-screen output

● Setting the MON2 ON EVENT

Sets whether the video of an event is output to the MON2 terminal while it is being recorded.

- ① Select "MON2 ON EVENT" using the control button (▲▼).
- ② Select ON or OFF using the control button (<>).
ON: The video of the event is output.
OFF: The video of the event is not output.

● Setting the MON2 EVENT DWELL TIME

If "MON2 ON EVENT" is set to ON, set the output duration of the video of the event.

- ① Select "MON2 EVENT DWELL TIME" using the control button (▲▼).
- ② Set the output duration (1 - 10 seconds) using the control button (<>).

LIVE settings

F

● Setting the SEQUENCE

Sets whether the output video automatically switches to the MON2 terminal.

- ① Select "**SEQUENCE**" using the control button (**▲▼**).
- ② Set ON/OFF using the control button (**<>**).
 - ON:** Automatically switches
 - OFF:** Does not automatically switch

● Setting the SEQUENCE-DWELL TIME

If "**SEQUENCE**" is set to ON, set the switching interval.

- ① Select "**SEQUENCE-DWELL TIME**" using the control button (**▲▼**).
- ② Set the switching interval (1 - 10 seconds) using the control button (**<>**).

● Setting the MON2 CHANNEL

Sets the channel that outputs the video to MON2 terminal.

<If "**SEQUENCE**" is set to OFF>

- ① Select "**MON2 CHANNEL**" using the control button (**▲▼**).
- ② Select the setting position using the control button (**<>**).
 - If "**MON2 TYPE**" is set to "**FULL**" set one channel if it is set to "**QUAD**" set 4 channels.
- ③ Select a channel (1 - 16) using the control button (**▲▼<>**).
 - 🔊 In DSR-2108, CH1 - CH8.
- ④ Move the cursor back to "**MON2 CHANNEL**" using the control button (**<>**).

<If "**SEQUENCE**" is set to ON>

- ① Select "**MON2 CHANNEL**" using the control button (**▲▼**).
- ② Select a channel using the control button (**▲▼**).
 - The factory default display hides the channel numbers.
- ③ To select ON or OFF for the automatic switch display (channel number display) press the ENTER button.

MON2-OUT				
MON2 TYPE	FULL			
MON2 ON EVENT	ON			
MON2 EVENT DWELL TIME	10 SEC			
SEQUENCE	ON			
SEQUENCE-DWELL TIME	10 SEC			
MON2 CHANNEL	1	2	3	4
	5	6	7	8
	-	-	-	-
	-	-	-	-

- ④ Move the cursor back to "**MON2 CHANNEL**" using the control button (**▲▼<>**).

RECORD settings

Press the MENU button and enter the password.
The MAIN MENU is displayed, select "RECORD" using the control button (▲▼<>).

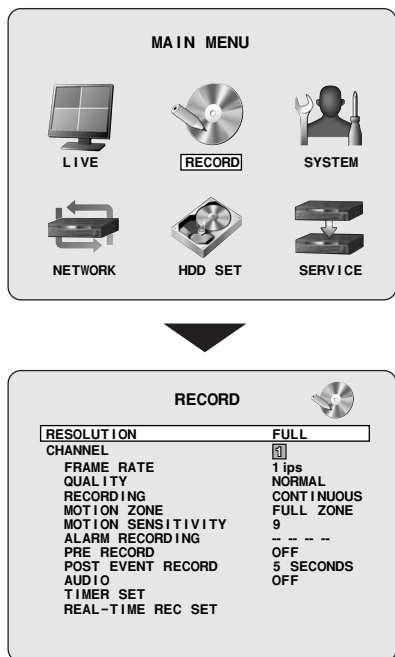

A Setting the RESOLUTION

To set the resolution for the recordings.

Select "RESOLUTION" using the control button (▲▼) and select a setting using the control button (<>).

FULL: NTSC: 704 × 480, PAL: 704 × 576
HALF: NTSC: 704 × 240, PAL: 704 × 288
QUAD: NTSC: 352 × 240, PAL: 352 × 288

B Setting a CHANNEL

To set the recording settings of each channel.

Select an item for each setting using the control button (▲▼) and select a setting value using the control button (<>).

● Setting a CHANNEL

Select "CHANNEL" and select a channel.

CH1 - CH16

In DSR-2108, CH1 - CH8.

● Setting the FRAME RATE (Unit: ips)

Select "FRAME RATE" and select a value.

NTSC: OFF/1/2/ ... 29/30 (ips)

PAL: OFF/1/2/ ... 24/25 (ips)



- Depending on the RESOLUTION settings, the total FRAME RATE available is limited as follows. If the total exceeds the limit the FRAME RATE of other channels cannot be set.

If FULL is selected under resolution setting:

NTSC: It is possible to select up to a total of 30 frames for channels 1 to 8 and up to a total of 30 frames for channels 9 to 16

PAL: It is possible to select up to a total of 25 frames for channels 1 to 8 and up to a total of 25 frames for channels 9 to 16

In DSR-2108, it is possible to select up to 30 (NTSC)/ 25 (PAL) frames.

If HALF is selected under resolution setting:

NTSC: It is possible to select up to a total of 60 frames for channels 1 to 8 and up to a total of 60 frames for channels 9 to 16

PAL: It is possible to select up to a total of 50 frames for channels 1 to 8 and up to a total of 50 frames for channels 9 to 16

In DSR-2108, it is possible to select up to 60 (NTSC)/ 50 (PAL) frames.

If QUAD is selected under resolution setting:

NTSC: It is possible to select up to a total of 120 frames for channels 1 to 8 and up to a total of 120 frames for channels 9 to 16

PAL: It is possible to select up to a total of 100 frames for channels 1 to 8 and up to a total of 100 frames for channels 9 to 16

In DSR-2108, it is possible to select up to 120 (NTSC)/ 100 (PAL) frames.

- Calculation of the total FRAME RATE is performed using the FRAME RATE set in the RECORD menu or the FRAME RATE set in the REAL-TIME REC SET menu, whichever is greater.

● Setting the QUALITY

To select "QUALITY" and select the video quality.

Selections: NETWORK/ECONOMY/BASIC/NORMAL/FINE

● Setting the RECORDING

To select "RECORDING" and select the recording mode.

- CONTINUOUS (P17)**

Recording is performed while this unit is turned on.

- MOTION recording (P17)**

Recording is performed as soon as the internal motion sensor of this unit reacts.

RECORD settings

B

- **ALARM (P18)**
Recording is performed as soon as a sensor device connected to the external alarm input terminal (ALARM IN) of this unit reacts.
- **SCHEDULE (P19)**
Recording is performed daily during the set time slot set on the TIMER SET screen in the recording settings.
- **DISABLE**
No recording is performed.

● Setting the MOTION ZONE (Refer to "MOTION recording": P17)

Select the zone where the motion sensor is active. It is necessary to set a detection frame when PARTIAL ZONE is selected.

- **FULL ZONE:**
The motion sensor is active on the whole screen.
- **PARTIAL ZONE:**
The motion sensor is active in the set detection frame.

● Setting the MOTION SENSITIVITY

To select "MOTION SENSITIVITY" and select the level of detection sensitivity of the motion sensor.

Selections: 1/2/ ... 8/9 (Low sensitivity level)

● Setting the ALARM RECORDING

Up to a maximum of 4 alarm input terminal numbers can be set to activate ALARM recordings.

ALARM recording is performed when an external alarm signal is input to the specified terminal.

● Setting the PRE RECORD

To select "PRE RECORD" and select pre-recording.

ON: Starts recording approximately 5 seconds before the internal motion sensor or the external sensor detector is triggered. (with 1 ips frame rate)

OFF: No pre-recording

● Setting the POST EVENT RECORD

To select "POST EVENT RECORD" and select in how much time, after the sensor detection, the recording will start.

Selections:
2 to 30 SECONDS, 1 to 5 MINUTES, 10 MINUTES, 15 MINUTES

● Setting the AUDIO

To select "AUDIO" and set the audio sound recording.

ON: Records the audio of live videos
To listen to audio sound connect an external microphone or speaker.

OFF: Does not record the audio of live videos.



Only CH1 - CH4 can record AUDIO.

C

Setting the TIMER SET

To perform SCHEDULE settings.

The recording schedule of each channel can be set using settings by the hour. (P19)

D

Setting the REAL-TIME RECSET

To trigger recording using the Record/Stop button or an external alarm input, select "REAL-TIME REC SET", and perform the following settings for each channel using the control buttons (▲▼<>).

• FRAME RATE

Sets the recording speed for real-time recording. (OFF, NTSC: 1 - 30 IPS, PAL: 1 - 25 IPS)

• QUALITY

Sets the image quality for real-time recording in 5 levels (NETWORK/ECONOMY/BASIC/NORMAL/FINE).

• EVENT

Sets the alarm input terminal number that triggers a real-time recording.

Input terminals:

DSR-2116: ----, 1 - 16

DSR-2108: ----, 1 - 8

• POST EVENT RECORD (Recording time)

Sets the duration of the real-time recording (--, 2 to 30 SECONDS, 1 to 5 MINUTES, 10 MINUTES, 15 MINUTES)

Memo: If "--" is selected, recording is triggered when the Record button is pressed or whenever an alarm input occurs.

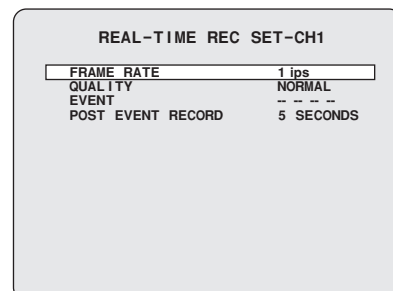
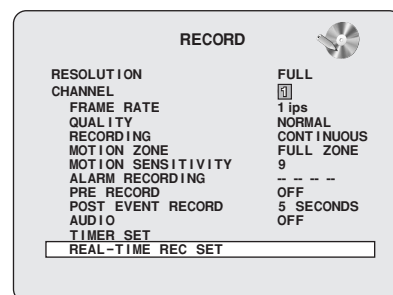

SYSTEM settings

Press the MENU button and enter the password.
The MAIN MENU is displayed, select "SYSTEM" using the control button (▲▼<>).

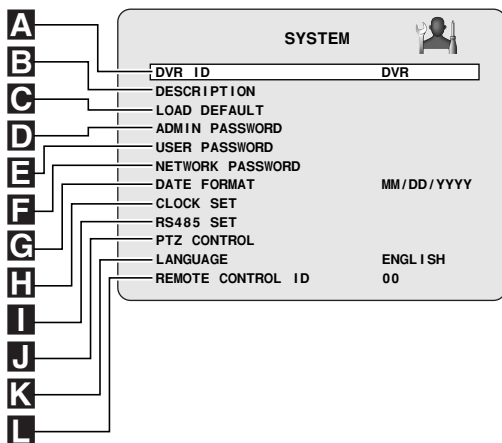
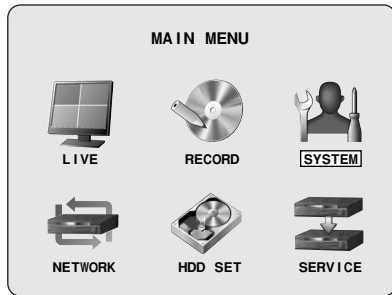

A Setting the DVR ID

Allows the individual designation of each unit when multiple units are connected.

- 1 Select "DVR ID" using the control button (▲▼) and press the ENTER button.

The DVR ID screen is displayed.

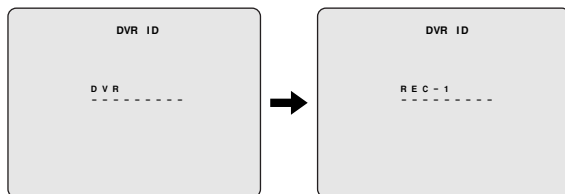

- 2 Input the unit designation (Example: REC-1) by pressing the control button (▲▼<>) repeatedly and press the ENTER button.

The changed unit designation is displayed in DVR ID on the SYSTEM screen.

Furthermore, the unit designation is entered in the sent mail when using "SEND E-MAIL" in "NETWORK" settings (P45).

B DESCRIPTION confirmation

To check the information related to the system of this unit.

Select "DESCRIPTION" using the control button (▲▼) and press the ENTER button.

The DESCRIPTION screen is displayed.

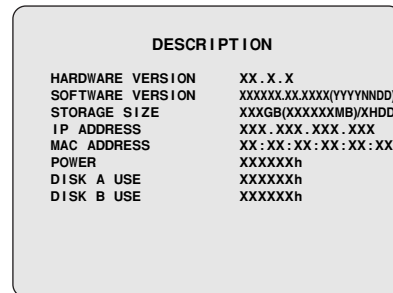

Memo: "POWER" indicates the duration for which the unit has been on.

"DISK A" is the master HDD and "DISK B" is the slave HDD.

C Setting the LOAD DEFAULT

To return to the factory default settings of the unit.

- 1 Select "LOAD DEFAULT" using the control button (▲▼) and press the ENTER button.

The LOAD DEFAULT screen is displayed.

- 2 Select "CONFIRM" using the control button (<>) and press the ENTER button.

The screen switches to the "INITIALIZING..." screen. The live video is displayed on the monitor.

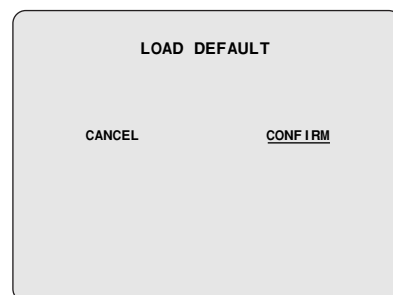

! CLOCK SET setting does not return to the default setting even when using "LOAD DEFAULT".

SYSTEM settings

D Setting an ADMIN PASSWORD

To set a password to perform menu settings, real time recording, search and playback. The initial value is "1111".

Memo: If no USER PASSWORD is set, no password is required when performing search and playback operations.

- 1** Select "ADMIN PASSWORD" using the control button (▲▼) and press the ENTER button.
The "Current" password input screen is displayed.
- 2** Input the current password (1111) using the camera selection button (1) and press the ENTER button.
The "New" password input screen is displayed.

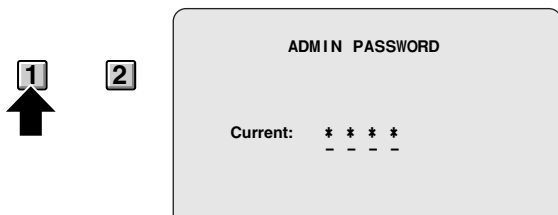

! If the password is input incorrectly the following message is displayed, press the ENTER button and input the correct password once again.
"INVALID CURRENT PASSWORD!!"

- 3** Input the new password (Example 2222) using the camera selection button (2) and press the ENTER button.
The "Confirm" password input screen is displayed.

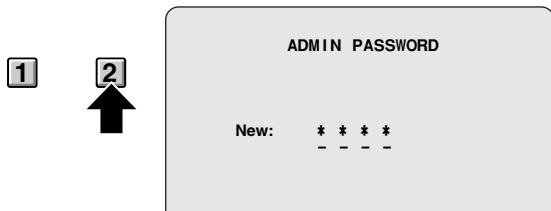

- 4** To confirm, input the new password once again and press the ENTER button.
The message "PASSWORD CHANGED!!" is displayed so press the ENTER button.
If the password is incorrect the message "PASSWORD MISMATCH!!" is displayed. Input the correct password again.

■ Settings for no password

It is possible to enter the menu settings screen without inputting a password.

- 1** Select "ADMIN PASSWORD" using the control button (▲▼) and press the ENTER button.
The "Current" password input screen is displayed.
- 2** Enter the current password using the camera selection button and press the ENTER button.
The "New" password input screen is displayed.

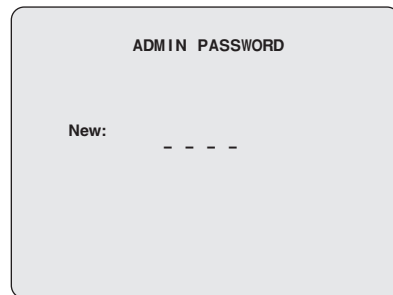
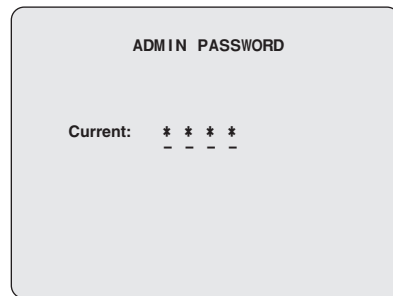

- 3** Press the ENTER button without inputting anything.
The "Confirm" password input screen is displayed.

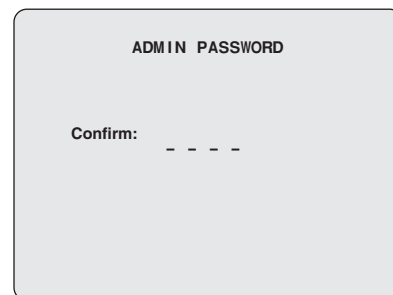

- 4** Press the ENTER button without inputting anything.
The message "PASSWORD CHANGED!!" is displayed so press the ENTER button.
To go to the live screen, press the EXIT/STOP button.

SYSTEM settings

D

Restoring the password input

- 1 Press the MENU button, select SYSTEM and press the ENTER button.
- 2 Select "ADMIN PASSWORD" using the control button (▲▼) and press the ENTER button.
The "Current" password input screen is displayed.

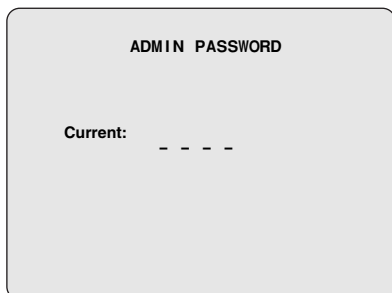

- 3 Press the ENTER button without inputting anything.
The "New" password input screen is displayed.
- 4 Input the new password using the camera selection buttons and press the ENTER button.
The "Confirm" password input screen is displayed.

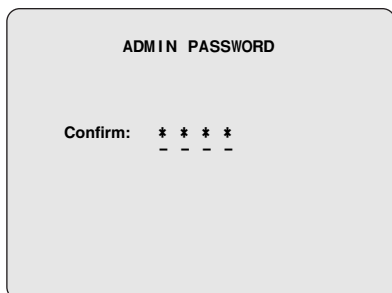
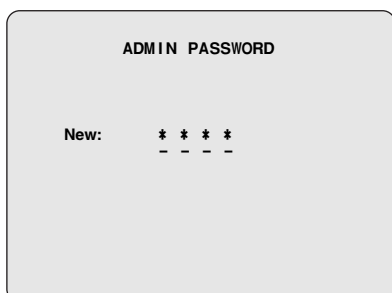

- 5 Enter the same password as in "New" using the camera selection button and press the ENTER button.
The message "PASSWORD CHANGED!!" is displayed so press the ENTER button.
To go to the live screen, press the EXIT/STOP button.

E

Setting the USER PASSWORD

This setting is used to give controlled operational access to administrators and general users. The operations with USER PASSWORD are **limited to search and playback**.
No user password is set by factory default. Set a password different from ADMIN PASSWORD.

- 1 Select "USER PASSWORD" using the control button (▲▼) and press the ENTER button.
The "Current" password input screen is displayed.
- 2 The following setting method is identical to the one described in "Setting an ADMIN PASSWORD".

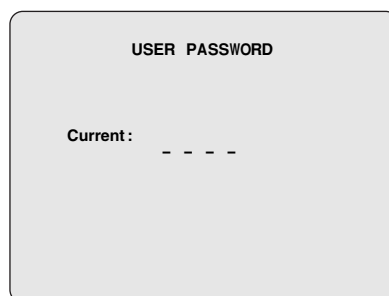

F

Setting a NETWORK PASSWORD

A password can be set to limit the access to the network for network users. The initial value is "1111".

- 1 Select "NETWORK PASSWORD" using the control button (▲▼) and press the ENTER button.
The "Current" password input screen is displayed.
- 2 The following setting method is identical to the one described in "Setting an ADMIN PASSWORD".

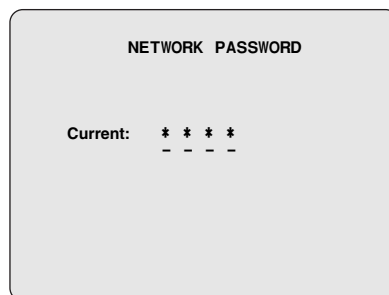

SYSTEM settings

G Setting the DATE FORMAT

Refer to "Setting the clock (CLOCK SET)". (P9)

H Setting the CLOCK SET

Refer to "Setting the clock (CLOCK SET)". (P9)

I Setting the RS485 SET

To be set when devices, such as a system controller or a SANYO protocol camera, are connected to the RS-485 control terminal.

- 1** Select "RS485 SET" using the control button ($\wedge \vee$) and press the ENTER button.

The "RS485 SET" screen is displayed.

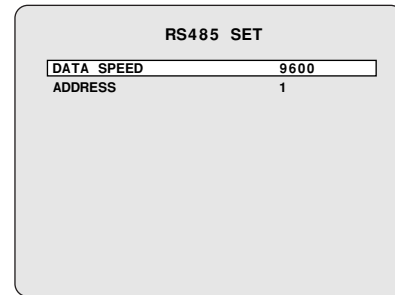

- 2** Select the item to be set using the control button ($\wedge \vee$) and select a setting value using the control button ($\langle \rangle$).

DATA SPEED: 2400/4800/9600/19200

ADDRESS: 0 - 128

J Setting the PTZ CONTROL

Refer to "Operating the PTZ dome camera". (P14)

K Setting the LANGUAGE

Refer to "Setting the language (LANGUAGE)". (P11)

SYSTEM settings

L Setting a REMOTE CONTROL ID

Allows to set an ID number on the supplied remote control and use it as an exclusive remote control when multiple units are connected.

The initial value is set to "00" and the remote control display is displayed on the monitor, remote operations are always available.

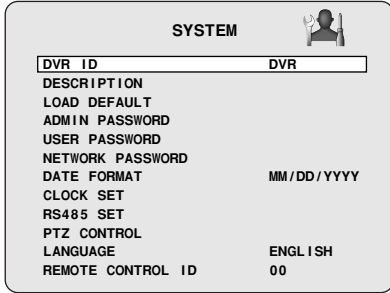

Remote control display

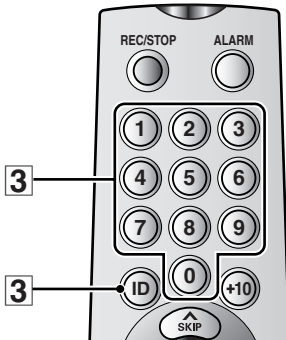
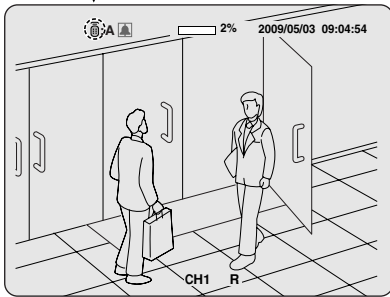

■ Operating this unit via the remote controller ID (Example: 4)

- 1 Select "REMOTE CONTROL ID" using the control button (▲▼) and select the ID number (Example: 04) using the control button (<>).
Selection: 01/02/ ... 98/99

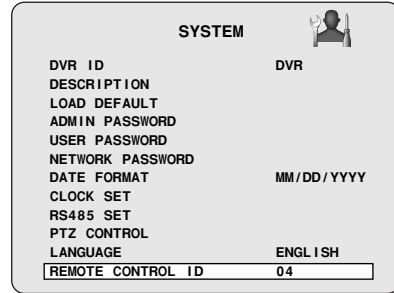

- 2 Press the EXIT/STOP button repeatedly to return to the live screen.
The remote display of the live screen disappears, an ID number is necessary to perform remote operations.
- 3 Press the ID button of the remote control and press "04" using the numeric buttons.

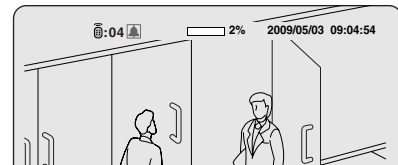
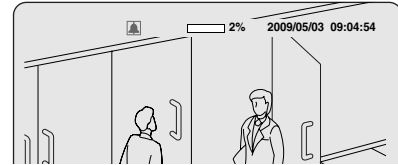

The remote control display reappears, the ID number 04 set in the SYSTEM settings allows the operation of this unit.

Memo: The remote control ID (04) currently in use is displayed on the monitor screen.
If no remote control ID has been set "A (ALL)" is displayed.

NETWORK settings

Press the MENU button and input the password.
The MAIN MENU is displayed, select "NETWORK" using the control button (▲▼<>).

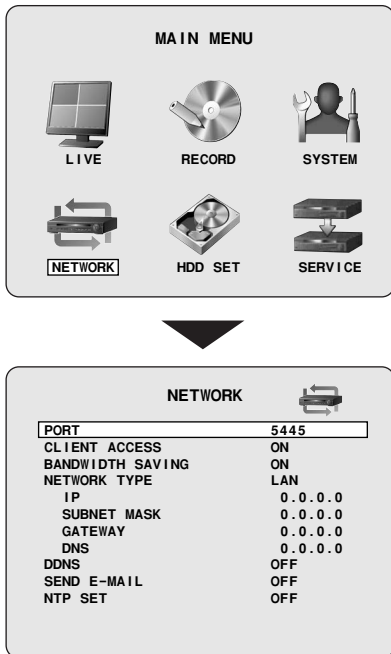

A Setting the PORT

When connecting this unit to a multiple unit network, set an individual port number.

- 1 Select "PORT" using the control button (▲▼) and press the ENTER button.

The "PORT" screen is displayed. The initial value is 5445.



- 2 Select a value using the control button (▲▼), and select a port number by repeating the operation using the control button (<>).

- 3 Press the EXIT/STOP button once operations are complete.

B Setting a CLIENT ACCESS

To give permission to operate from an external PC.

Select "CLIENT ACCESS" using the control button (▲▼), and set "ON" using the control button (<>).

ON: Accessing the unit via a PC using the supplied exclusive software

OFF: Does not allow access

C Setting the BANDWIDTH SAVING

Set if the network bandwidth is not large enough when monitoring live videos.

Select "BANDWIDTH SAVING" using the control button (▲▼), and set the settings using the control button (<>).

ON: Live videos advance frame by frame (At the rate of 1 frame per second)

OFF: Does not limit the network bandwidth

NETWORK settings

D Setting the NETWORK TYPE

Select "NETWORK TYPE" to be connected, and set each setting. Consult the network manager for all necessary information.

- 1 Select "NETWORK TYPE" using the control button (▲▼).
- 2 Select a type using the control button (▲▼).
Selection: DHCP, ADSL, LAN

DHCP

NETWORK	
PORT	5445
CLIENT ACCESS	ON
BANDWIDTH SAVING	ON
NETWORK TYPE	DHCP
DDNS	OFF
SEND E-MAIL	OFF
NTP SET	OFF

ADSL

NETWORK	
PORT	5445
CLIENT ACCESS	ON
BANDWIDTH SAVING	ON
NETWORK TYPE	ADSL
ID	
PASSWORD	
DDNS	OFF
SEND E-MAIL	OFF
NTP SET	OFF

LAN

NETWORK	
PORT	5445
CLIENT ACCESS	ON
BANDWIDTH SAVING	ON
NETWORK TYPE	LAN
IP	0.0.0.0
SUBNET MASK	0.0.0.0
GATEWAY	0.0.0.0
DNS	0.0.0.0
DDNS	OFF
SEND E-MAIL	OFF
NTP SET	OFF

■ If selecting ADSL

- 1 Select "ID" using the control button (▲▼) and press the ENTER button.
The ADSL ID input screen is displayed.
- 2 Change the ID number using the control button (▲▼), move the cursor to the right using the control button (<>) and repeat the operation, and then press the ENTER button.
The screen returns to the NETWORK screen.
- 3 Select "PASSWORD" using the control button (▲▼) and press the ENTER button.
The ADSL PASS input screen is displayed.

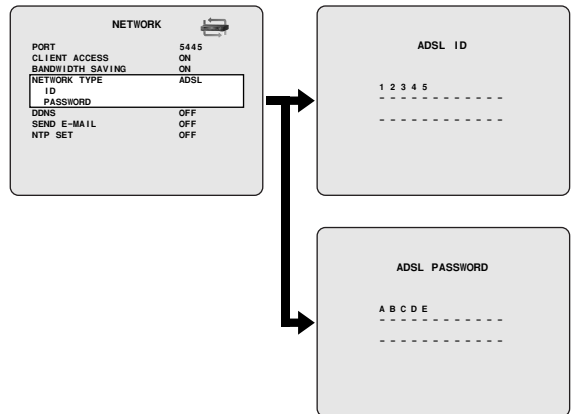

- 4 Display "ADSL PASSWORD" using the control button (▲▼), enter the password by moving the cursor to each digit with the control button (<>), then press the ENTER button.
The screen returns to the NETWORK screen.
- 5 Press the EXIT/STOP button.
The APPLY NETWORK ADDRESS screen is displayed.
- 6 Select "CONFIRM" using the control button (<>) and press the ENTER button.
Once the settings are complete, restart the unit. The screen switches to live video.

APPLY NETWORK ADDRESS	
CANCEL	CONFIRM

■ If selecting DHCP

Information, such as the IP address, is automatically distributed and does not therefore need to be set.

NETWORK settings

D

■ If selecting LAN

- 1 Select "IP" using the control button (▲▼) and press the ENTER button.
The IP ADDRESS input screen is displayed.
- 2 Change the IP number using the control button (▲▼), move the cursor to the right using the control button (<>) and repeat the operation, and then press the ENTER button.

The screen returns to the NETWORK screen.

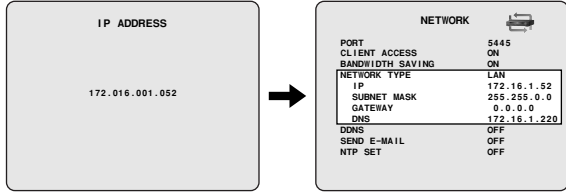

- 3 Repeat 2 and change the following as necessary.

- SUBNET MASK



- GATEWAY

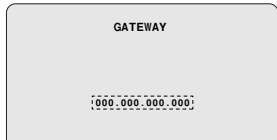

- DNS

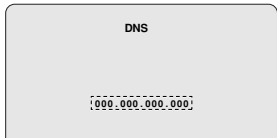

- 4 Press the EXIT/STOP button.
The APPLY NETWORK ADDRESS screen is displayed.
- 5 Select "CONFIRM" using the control button (<>) and press the ENTER button.
Once the settings are complete, restart the unit. The screen switches to live video.

E Setting the DDNS

Register the domain name and set the DDNS server when using Sanyo's DDNS service.

- 1 Select "DDNS" using the control button (▲▼) and select "SANYO" using the control button (<>).

The DDNS SERVER SET menu is displayed.

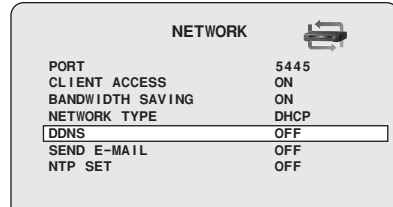

- OFF: Do not connect to the DDNS server
- SANYO: Connect to Sanyo's DDNS server
- ETC: Connect to another company's DDNS server (consult the dealership where this unit was purchased or a "Repair Service Center").

- 2 Select "DDNS SERVER SET" using the control button (▲▼) and press the ENTER button.

The DDNS SERVER SET screen is displayed.

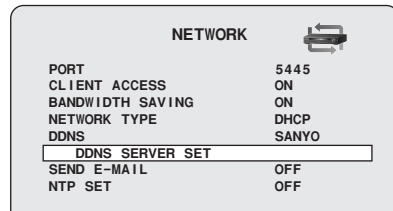

- 3 Confirm the "USER ID" and "PASSWORD" displayed on the screen.

Ensure that the USER ID and PASSWORD are written down as they are required to register the domain name.

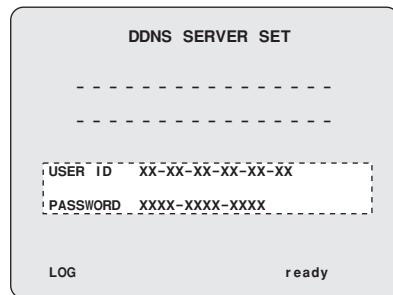

- 4 Start Internet Explorer on the computer and access Sanyo's DDNS service.

When the following address is entered the login screen of the DDNS service is displayed.

<https://www.ddns-sanyosecurity.com>

NETWORK settings

5 Enter the "USER ID" and "PASSWORD" confirmed on the DDNS SERVER SET screen and click the Login button.

The domain name registration screen is displayed. Enter the "USER ID" and "PASSWORD" in capital letters.

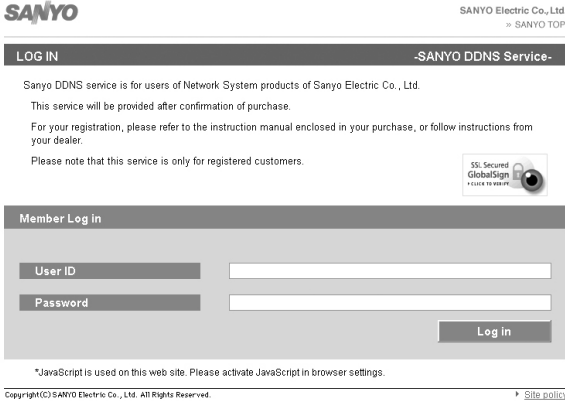

6 Enter the domain name to be used and click the Submit button.

The domain name is registered to the DDNS server.

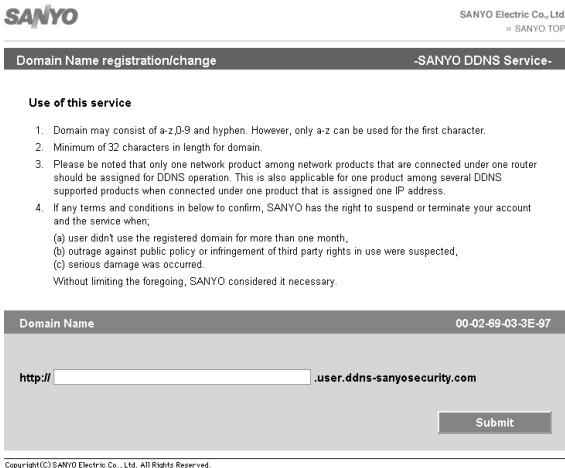

7 Return to the DDNS SERVER SET screen of this unit and enter the registered domain name.

Select the input location using the control button (<>) and select a character using the control button (▲▼).

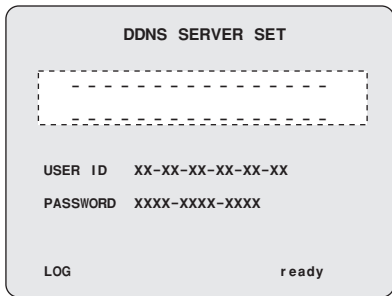

8 Press the ENTER button.

The DDNS settings complete, the screen returns to the NETWORK screen.

F Setting the SEND E-MAIL

An E-mail can be sent to a specified IP address.

1 Select "SEND E-MAIL" using the control button (▲▼), select "ON" using the control button (<>) and press the ENTER button.

The SEND E-MAIL screen is displayed.

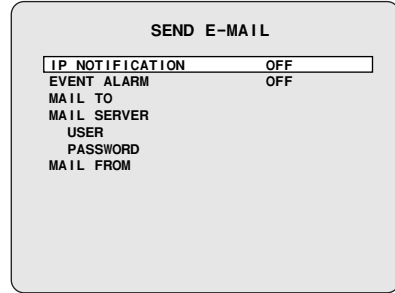

- **ON:** Enable the sending e-mail function
- **OFF:** Disable the sending e-mail function

2 Select the following item using the control button (▲▼) and select the setting using the control button (<>).

- **IP NOTIFICATION:**
 - ON:** Does not send a notification E-mail even when an event alarm is triggered.
 - OFF:** Does not send an E-mail
- **EVENT ALARM:**
 - OFF:** Does not send a notification E-mail even when an event alarm is triggered.

ALARM:

A notification e-mail is sent when ALARM recording is triggered by the sensor connected to the external alarm input terminal (ALARM IN) of the unit.

MOTION:

A notification e-mail is sent when MOTION recording is triggered by a movement detected by the motion sensor built into the unit.

ALL:

A notification e-mail is sent when a recording is triggered either by an external alarm or the built-in motion sensor.

Memo: EVENT ALARM requires setting of ALARM-SET. (P32)

3 Select the following item using the control button (▲▼) and set the information, such as the E-mail address, using the control button (▲▼<>).

Pressing the EXIT/STOP button returns the screen to the SEND E-MAIL screen.

NETWORK settings

F

- **MAIL TO**
To set the destination mail address.
Example:

MAIL TO

@ s a n y o . c o m

- **MAIL SERVER**
Sets the mail server name, as well as the USER and PASSWORD.
Example:

MAIL SERVER

m a i l s e r v e r 1 2

USER: To set the connection user ID for the mail server.
PASSWORD: To set the connection password for the mail server.

Example:

USER

2 3 4 5 6

PASSWORD

2 0 0 6 0 9 1 5

- **MAIL FROM**
To set the mail address sent to the destination host.
Example:

MAIL FROM

1 1 1 @ A B C . c o m

- **4** Press the EXIT/STOP button twice.
The screen returns to the NETWORK screen and then press the EXIT/STOP button again.

G Setting the NTP SET

Allows synchronizing the time using an internet or LAN NTP server.

- **1** Select "NTP SET" using the control button (ΛV), select "ON" using the control button (<>) and press the ENTER button.
The NTP SET screen is displayed.

NTP SET

NTP SERVER ADDRESS1	0.0.0.0
NTP SERVER ADDRESS2	0.0.0.0
TIME ZONE	GMT +9:00
TIME TO SYNCHRONIZE	01:00

- **ON:** Use NTP server to adjust time
- **OFF:** NTP server not used for adjusting time

- **2** Select the following item using the control button (ΛV) and press the ENTER button.
Set the NTP server address using the control buttons (ΛV<>) and press the ENTER button.
 - NTP SERVER ADDRESS1
 - NTP SERVER ADDRESS2

- **3** Select "TIMEZONE" using the control button (ΛV) and the time zone using the control button (<>).
Selections: GMT -1:00 to -12:00, 0:00 to 13:00

- **4** Select "TIME TO SYNCHRONIZE" using the control button (ΛV) and the time to synchronize using the control button (<>).
Selections: 00, 01, 02 - 23
Press the EXIT/STOP button to return to the NETWORK settings screen.

HDD SET settings

Press the MENU button and input the password.
The MAIN MENU is displayed, select "HDD SET" using the control button (▲▼<>).

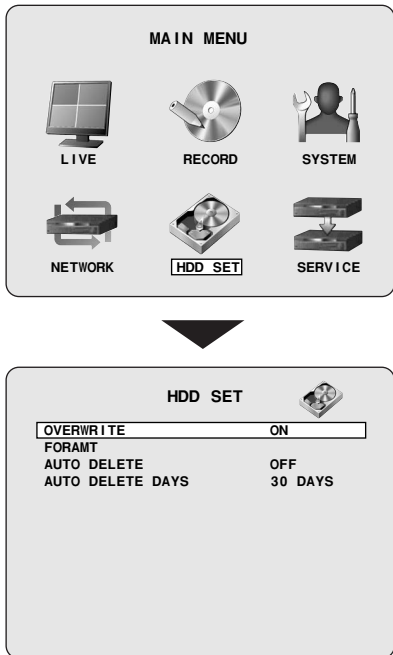

A Setting the OVERWRITE

Allows continuing recording and overwriting old videos once the hard disk capacity is full.

! When OVERWRITE is set to ON, save required videos to an external memory device. (P26)

Select "OVERWRITE" using the control button (▲▼) and select a setting using the control button (<>).

ON: When the capacity becomes full, former data is overwritten and the recording continues

OFF: When the capacity becomes full the recording stops

B FORMAT settings

Initializes the internal hard disk.

! All the videos are lost. Before formatting, save required videos to an external memory device. (P26)

1 Select "FORMAT" using the control button (▲▼) and press the ENTER button.

The FORMAT screen is displayed.

2 Select "CONFIRM" using the control button (<>) and press the ENTER button.

Formatting starts.

Once formatting is complete, the unit restarts and returns to live videos.

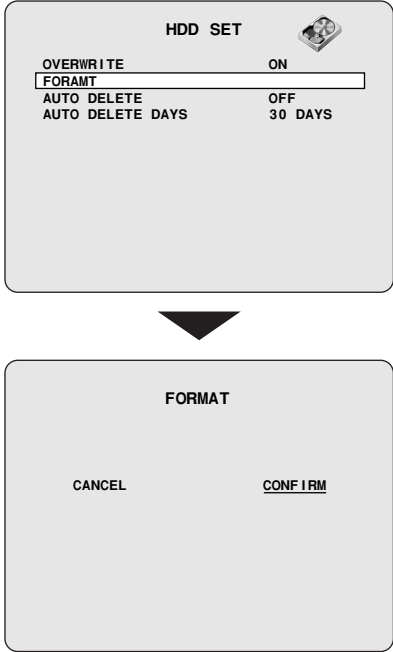

HDD SET settings

C Setting the auto delete function

Allows the user to set the storage period for the recording data.

Once the storage period is expired the data is automatically deleted.

- 1** Select "AUTO DELETE" using the control button ($\wedge \vee$) and select a setting using the control button ($\langle \rangle$).

ON: The auto delete function is enabled

OFF: The auto delete function is disabled

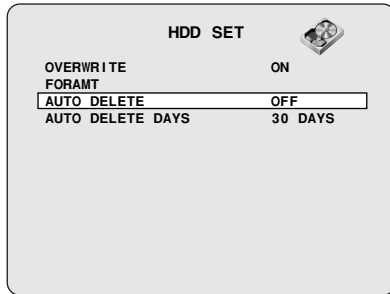

- 2** Select "AUTO DELETE DAYS" using the control button ($\wedge \vee$) and set the storage period using the control button ($\langle \rangle$).

If AUTO DELETE is set to "ON", set a recording data storage period.

Selection: 2/3/4 ... 60DAYS



The recording data beyond the set period cannot be played back.

SERVICE settings

Press the MENU button and input the ADMIN password.
The MAIN MENU is displayed, select "SERVICE" using the control button (▲▼<>).

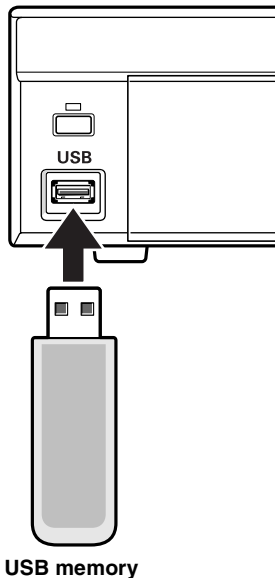
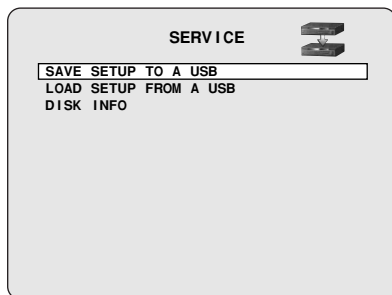
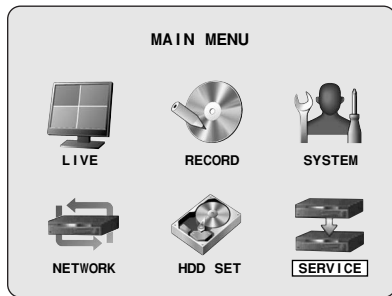

A Setting the SAVE SETUP TO A USB

Saving the menu settings of this unit to a device, such as a USB memory.

- 1 Connect the USB memory to the USB terminal.
- 2 Select "SAVE SETUP TO A USB" using the control button (▲▼) and press the ENTER button.
The confirmation screen is displayed.
- 3 Select "CONFIRM" using the control button (<>) and press the ENTER button.
The message "SAVING" is displayed and saving starts. Once saving is complete the SERVICE screen is displayed.

B Setting the LOAD SETUP FROM A USB

Allows to call up the menu settings of this unit saved on such a device as USB memory onto this unit or onto a device of identical model.

- 1 Connecting the USB memory containing the menu settings to the USB terminal.
- 2 Select "LOAD SETUP FROM A USB" using the control button (▲▼) and press the ENTER button.
The confirmation screen is displayed.
- 3 Select "CONFIRM" using the control button (<>) and press the ENTER button.
The message "LOADING" is displayed and loading starts. Once loading is complete, the unit restarts and returns to live videos.

C Displays the hard disk information

Select "DISK INFO" using the control button (▲▼) and press the ENTER button.

The following data is displayed on the DISK INFO screen.

- Total capacity of the hard disk
- Remaining capacity of the hard disk
- Date and time of first recording
- Date and time of last recording

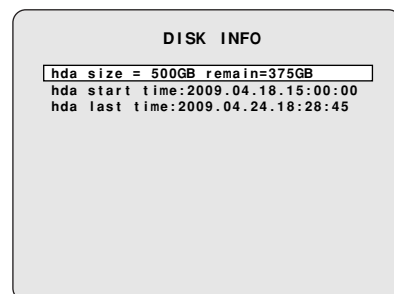

Operations using the Network

This unit can be operated from a PC screen by using the supplied network operation software "Sanyo DVR Utility 2000S". Prior to performing network operations make the following preparations.

Connection and settings

- **Network connection:**

Connect this unit and the PC using a LAN or Internet connection. (P5)

- **Network settings:**

Set the network connection settings on the NETWORK screen of this unit. (P42)



- The IP address and other settings on the PC must be appropriate for the connection.
- The maximum number of PCs that can be connected to one DVR is 4.

Operating environment

- **CPU:** Intel Pentium4 1.2 GHz or higher
- **Memory:** Windows VISTA: Minimum 512 MB (1 GB or higher recommended)
Windows XP: Minimum 256 MB (512 MB or higher recommended)
- **VGA:** 16 MB (64 MB recommended)
- **Resolution:** 1024 × 768
- **Disk capacity:** 10 MB (More than 2.1GB when using Sanyo recording software)
- **Operating System:**
Windows VISTA,
Windows XP Professional SP2/Windows XP Home
- **Direct X:** Direct X 8.1 or above

Installing "Sanyo DVR Utility 2000S"

Install using the interactive screen.

- 1** Insert the supplied CD-ROM in the CD drive and double-click "Sanyo Client.exe".

The installer runs.

- 2** Confirm the installation destination folder on the "Choose Destination Location" screen and click [Next].

To change the installation destination folder, click [Browse] and select a folder.

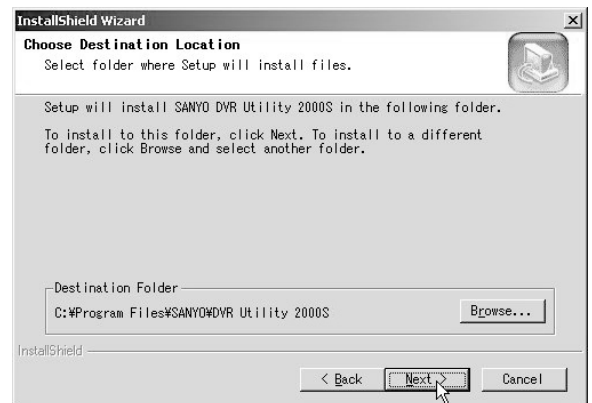

Operations using the Network

To uninstall the software

Specify "**SANYO DVR Utility 2000S**" in the control panel [Add or Remove Programs] and uninstall.

- 3 Select the setup type on the [Setup Type] screen and click [Next].



- In general, select "**Typical**". Depending on the performance of the PC the program may not operate. In that case, re-install "**Light**".

- 4 Confirm the program folder in the "Select Program Folder" screen and click [Next].

To install to a different program folder, input the folder name in the box directly or select a folder from the [Existing Folders] list.

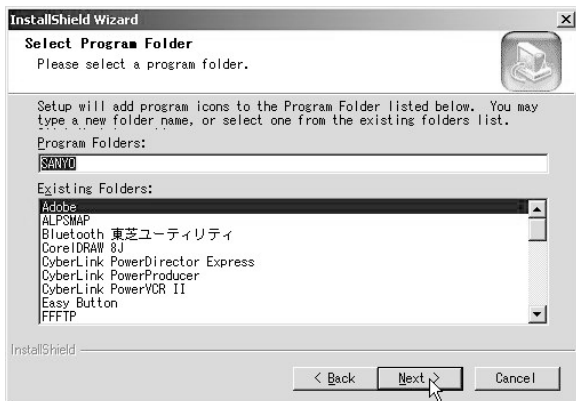

- 5 The software starts installing.

The progress of the installation is displayed on the "**Setup Status**" screen.

- 6 Installation is complete.

Once the installation is complete, the "**DVR Utility 2000S**" shortcut icon is displayed on the desktop.



Double-click this icon to start the software.

Connecting to this unit

To start this software, double-click the desktop shortcut icon (), the main screen is displayed. When connecting a camera to this unit following the procedure below, the camera live video is displayed.

■ Connecting for the first time

1 Click the connect button on the operation panel.



The connection dialog [Connect] is displayed.

☞ In DSR-2108, the multi-screen switch button displays a multi-8 screen.

2 Input information such as the address information and settings required for the connection.

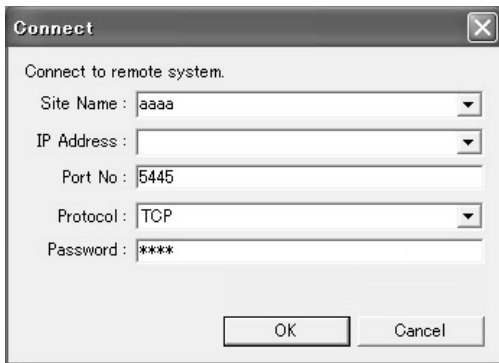

- **Site Name:**
Set up an administrative designation for this unit.
- **IP Address/Port No.:**
Input the IP address and PORT number set on the NETWORK screen of this unit.
When using DDNS, input the set domain name into "IP Address".

⚠ **Apart from the port that has been set (e.g., 5445), the port number plus 1 (e.g., 5446) and the port number plus 10 (e.g., 5455) are used.**

- **Protocol:**
Select the protocol (TCP/UDP).
- **Password:**
Input the network password set on the SYSTEM screen of this unit.

⚠ **This unit cannot be connected to the network if the [CLIENT ACCESS] on the NETWORK screen is not set to "ON". (P42)**

3 Click [OK] on the dialog [Connect].
The camera connects to this unit and the live video of the camera is displayed on the main screen.

■ Disconnecting

Once connected, the **connect** button on the operation panel changes to the **disconnect** button.

Clicking this button disconnects the connection with this unit and the displayed video disappears.



☞ In DSR-2108, the multi-screen switch button displays a multi-8 screen.

■ When there are several connections

The connection information used with this unit is displayed at once under the site name in the "----Select Site----" pull down menu.

To change the connection destination, select Site Name in the pull down menu and click. The present connection is disconnected and the specified site is automatically connected.

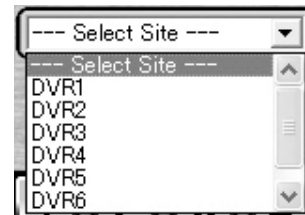

-
- Memo:**
- To change the connection destination using the connection button, disconnect the present connection using the disconnect button and perform the connection operations again.
 - Editing of the registered connection information such as additions changes or deletions may be performed under "Site" in the set up menu.

Main screen structure and function of each part

When connected to this unit, the live video of the camera is displayed on the main screen.

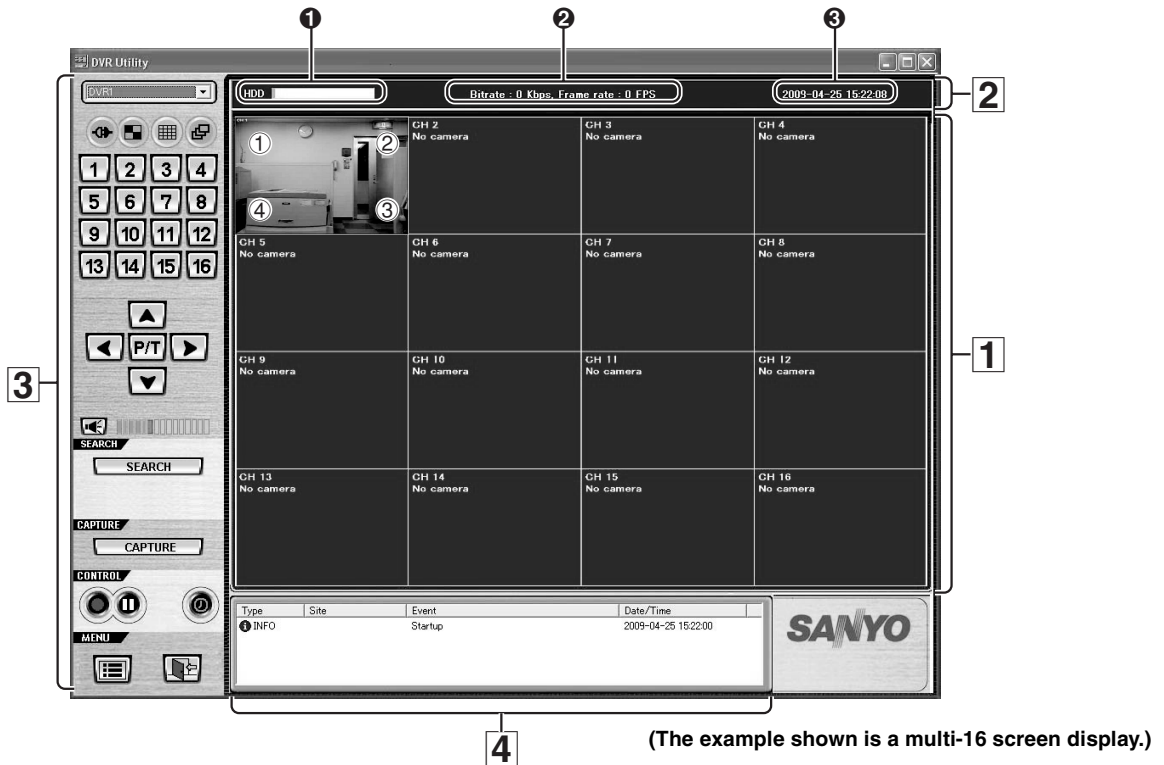

1 Video display area

Displays live video or playback video.

<Screen display method>

Can be switched using the operation button on the screen. (P55)

- Single-screen
- Quad-screen
- Multi-screen (multi-9 screen / multi-16 screen)
- Sequence (camera switch) display
- Full-screen display

☞ In DSR-2108, the only available multi-screen is multi-8 screen.

<Camera information>

The following camera information is displayed on each camera video.

① (Top left):

- **Camera channel (CH1 - 16)**
- **Camera designation**
To change the camera designation, go to the **camera designation settings (Site)** screen in the set up menu. (P63)
(When no camera is connected to the channel, the message "No Camera" is displayed.)
☞ In DSR-2108, CH1 - CH8.

② (Top right):

- M:** MOTION recording in progress (P17)
- A:** ALARM recording in progress (P18)

③ (Bottom right):

- R:** Recording in progress

④ (Bottom left):

- A:** Alarm output in progress (P54)

Memo: Video is shown in the same channel as the alarm output terminal number.

2 Information display area

The following information is displayed.

① Shows the used capacity of the hard disk of this unit

② Communication bit rate and frame rate

To display, set in the set up menu in the general setting screen. (P62)

③ Date and time information

For live video: Current date and time

For playback video: Recorded date and time

3 Operation panel (P54)

The view operation buttons are arranged on the panel.

4 Log window

The operation history is displayed as a list.

Displayed items: Type, Site, Event, Date/Time

Memo: Click [SEARCH] on the operation panel to switch the screen to search mode. One part of the operation panel display and one part of the log window display change. (P59)

Main screen structure and function of each part

Function of the operation panel

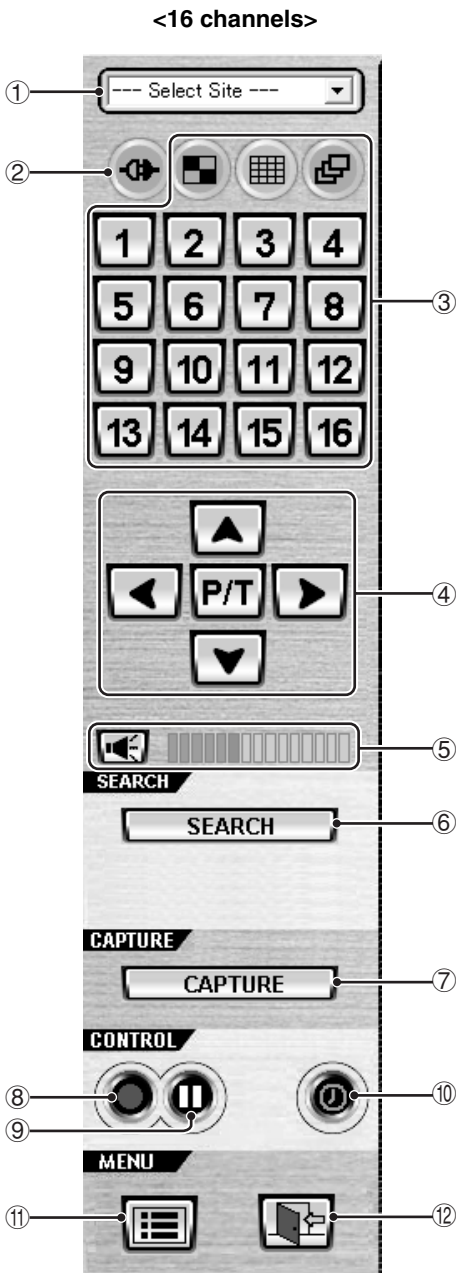

SW : The display of the icon changes according to the selection made.

① Scrolling connected sites (Select Site)

To change the connection destination select the site name of the connection destination using the pull down menu. (Normally the site name of the present connection destination is displayed.)

② Connect/Disconnect button

- SW** : Displays the [Connect] dialog for connection (P52)
- SW** : Disconnects the connection

③ Screen display switch button (P55)

- : Switching to quad-screen display
- : Changing the display to a multi screen (multi-16 screen/ multi-9 screen)
- : To sequence (automatic camera switch) display
- 1 - 16** : Selecting a channel and switching to single-screen display

In DSR-2108, only multi-8 screen is available since the number of available channels is 8.

④ Camera controller (Only for PTZ dome camera)

When clicking the controller button (**P/T** / **Z/F**), the controller display changes. (P58)

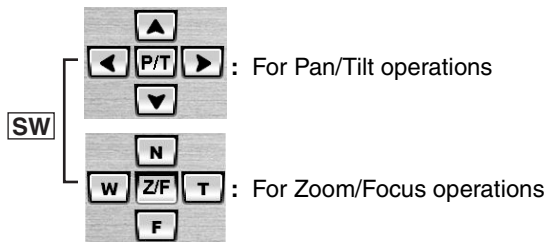

⑤ Audio controller

Adjusts the audio output of live video and playback video.

- SW** : The audio is not output
- SW** : The audio is output
- VOLUME** : Adjusts the output volume

⑥ [SEARCH] button

Switches the main screen to search mode (P59)

⑦ [CAPTURE] button

Saving images (P57)

⑧ Recording button (P56)

- SW** : Sets recording function to ON (Recording to PC hard disk)
- SW** : Sets recording function to OFF

⑨ Still button (P57)

- SW** : Freezes the live video on PC
- SW** : Unfreezes the live video on PC

⑩ Alarm output switch button

- : Switches the alarm output (ALARM OUT 1) on the back panel to ON/OFF (A The red button light up when an alarm output is in progress)

⑪ Menu button

- : Displays the set up menu screen (P62)

⑫ Exit button

- : Exits the software and closes the screen

Main screen basic operations

A Switching the display mode of the screen

Allows you to select the display mode for live and playback video.

■ Single-screen display

Click the channel selection button on the operation panel or select one screen and double-click.

The video of the specified camera is displayed in single-screen.

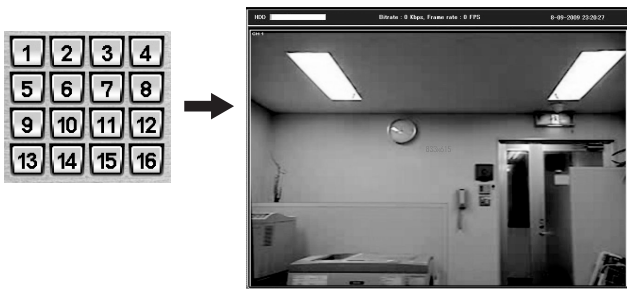

Memo: Double-clicking on a single-screen display returns the previous screen display.

■ Quad-screen display

Click the quad-screen display button on the operation panel.

The video of the cameras connected to this unit is displayed on quad-screen.

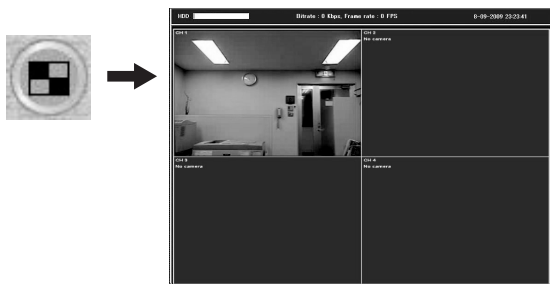

Memo: Each time the button is clicked the video of the next four channels is displayed in order of the channel numbers.

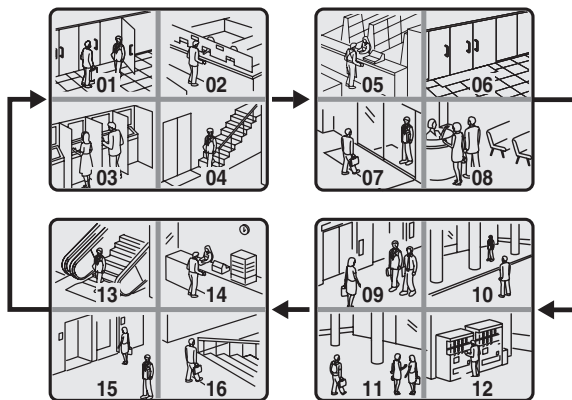

In DSR-2108, the unit of 4 screens, 1 to 4 and 5 to 8, are displayed in sequence.

■ Multi-screen display

Click the multi-screen display on the operation panel.

The video of the cameras connected to this unit is displayed on multi-16 screen or multi-9 screen.

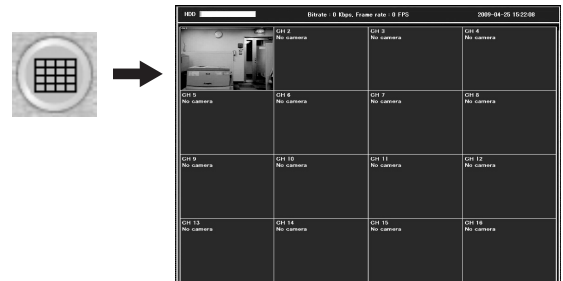

In DSR-2108, the only available multi-screen is multi-8 screen.

Memo: Each time the button is clicked the display switches in turn from the multi-16 screen to the multi-9 screen (2 patterns) video.

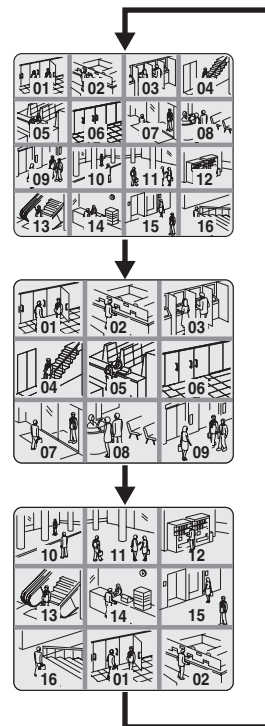

Memo: <About selecting a camera video>

If a live video is selected (clicked) on the quad-screen or multi-screen display, a red frame appears around the live video to indicate that it is selected.

It is necessary to select a camera to perform the following operation in quad-screen or multi-screen.

- Saving images (P57)
- PTZ dome camera operations (P58)
- Switching the audio output (⑤ Audio controller: P54)

Main screen basic operations

A

Sequence (camera switch) display

Click the sequence button on the operation panel while in single, quad-screen, or multi-9 screen display.

The video is displayed in sequence in the order of the channel numbers in the present selected display layout.

(Multi-9 screen sequence is available in DSR-2116 only.)



When using quad-screen display

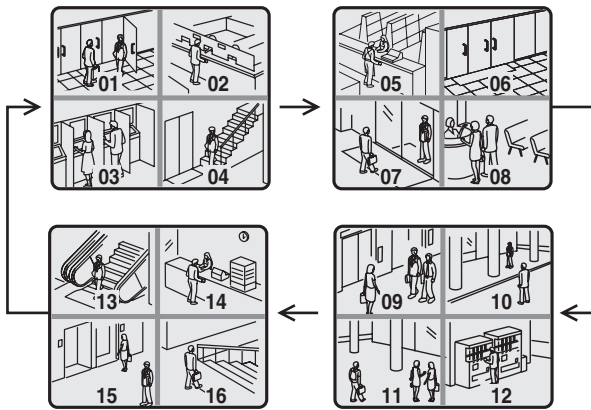

When the button is re-clicked, sequence display stops and display returns to normal single-screen display.

In DSR-2108, the unit of 4 screens, 1 to 4 and 5 to 8, are displayed in sequence.

Full-screen display

Click the maximize button on the extreme right of the title bar.

Displays, such as the operation panel displays, are hidden and only the video area is maximized and displayed.

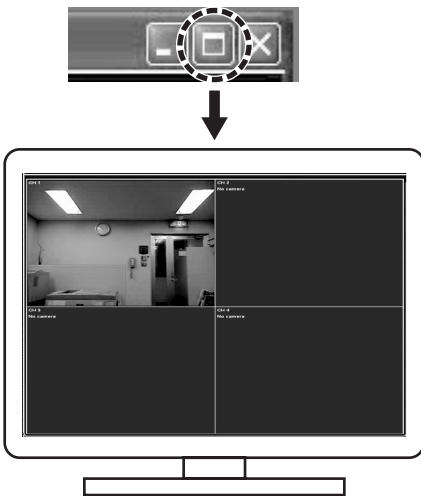

Press the [Esc] button to return from the full-screen to the standard screen.



The operation panel is not displayed while in full-screen. Therefore, no operation can be performed except for switching display by double-clicking the screen.

B

Recording live video

Recording method

The present software allows two modes of recording live video from a camera. Automatic recording setting is also available.

<Recording mode>

- **Always:**
Recording is performed when the recording button on the operation panel is set to ON.
- **Event:**
When the recording button on the operation panel is set to ON, recording is on standby and recording is performed when specified events occur.

<Automatic recording>

When set to automatic recording, the Recording/Stop button becomes ON as soon as the DVR Utility 2000S is started. Recording is performed automatically in the selected mode even without operating the recording button on the operation panel.

- Memo:**
- Set the automatic recording or select a recording mode on the recording settings screen in the set up menu. (P65)
 - Network operation video recordings are all saved on the PC hard disk. Set the save conditions in the disk settings screen in the set up menu. (P65)
 - No changes to the connected site can be performed while recording using network operations is in progress.
 - Audio is not recorded.

Switching recording functions

Switch the recording functions to ON/OFF using the recording button on the operation panel.

1

Clicking the recording button on the operation panel.

The recording function changes to ON and the button display switches to stop.



Setting the recording function to ON allows recording according to the recording mode.

- **In Always mode:**
Starts the recording onto PC hard disk
- **In Event mode:**
Recording is on standby, recording onto PC hard disk starts when a specified event occurs

2

To stop the recording function

Click the recording button (Stop) on the operation panel.



- **In Always mode:** Stops recording
- **In Event mode:** Cancels recording standby

Main screen basic operations

C Freezing the live video

Stops the live video and allows the user to view the live video as a still image.

- 1 Click the still button on the operation panel.**
The live video changes to still video, the still button display switches to the unfreeze button.



Pausing the video will also stop the live audio.

- 2 To unfreeze the image**
Click the unfreeze button on the operation panel.



The live video returns to moving video.

D The audio is output

Audio output is available for live and playback video.

- 1 Click the audio button on the operation panel.**
The audio is output and the button switches to no output.



Adjust the output volume by dragging and dropping [VOLUME].

- 2 To stop the audio output.**
Click the audio button on the operation panel.



E Saving images

Allows the user to save live video or playback video displayed on the screen on the PC, as still images.

- 1 Selecting the camera video to be saved.**
When in quad-screen display, select 1 camera video and click (a red frame surrounds the selected camera) or double-click to switch to single-screen display.
- 2 Click [CAPTURE] on the operation panel.**
The [Image capture] dialog is displayed.
- 3 Set the saving conditions using the dialog.**

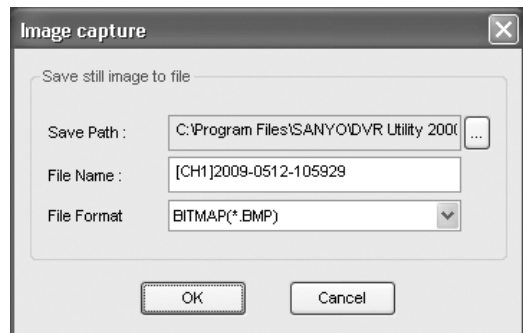

- 1 Save Path:**
The path set in the general settings screen in the set up menu is displayed. (P62)
- 2 File Name:**
Change the path and input a new path in the box.
- 3 File Format:**
JPEG or BITMAP can be selected.
- 4 Click [OK] in the [Image capture] dialog.**
One screen image is saved when [CAPTURE] is clicked.

Main screen basic operations

F Operating the PTZ dome camera

When the PTZ dome camera is connected to this unit, it can be remotely operated from the PC.

- 1 Sets the menu using this unit.**
Set the PTZ CONTROL settings on the SYSTEM screen of the menu settings of this unit. (P14)
- 2 Displays the live video and specifies the camera to be operated.**
When in quad-screen display, select 1 camera video and click (a red frame surrounds the selected camera) or double-click to switch to single-screen display.
- 3 Operates the camera using the camera controller on the operation panel.**
Clicking the controller button (**P/T** / **Z/F**) switches the controller display.

■ For Pan/Tilt operations

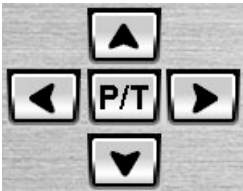

- ▲ ▼** : Adjusts the tilt
- ◀ ▶** : Adjusts the pan
- P/T** : Switches the controller button to Zoom/Focus operations

■ For Zoom/Focus operations



- T W** : Adjusts the zoom
- N F** : Adjusts the focus
- Z/F** : Switches the controller button to Pan/Tilt operations

Search mode operations

When clicking [SEARCH] on the operation panel, the screen display switches to search mode. When in search mode, the display of one part on the operation panel as well as one part of the log window changes. Search and backup operations of video recorded on this unit or on the PC become available.

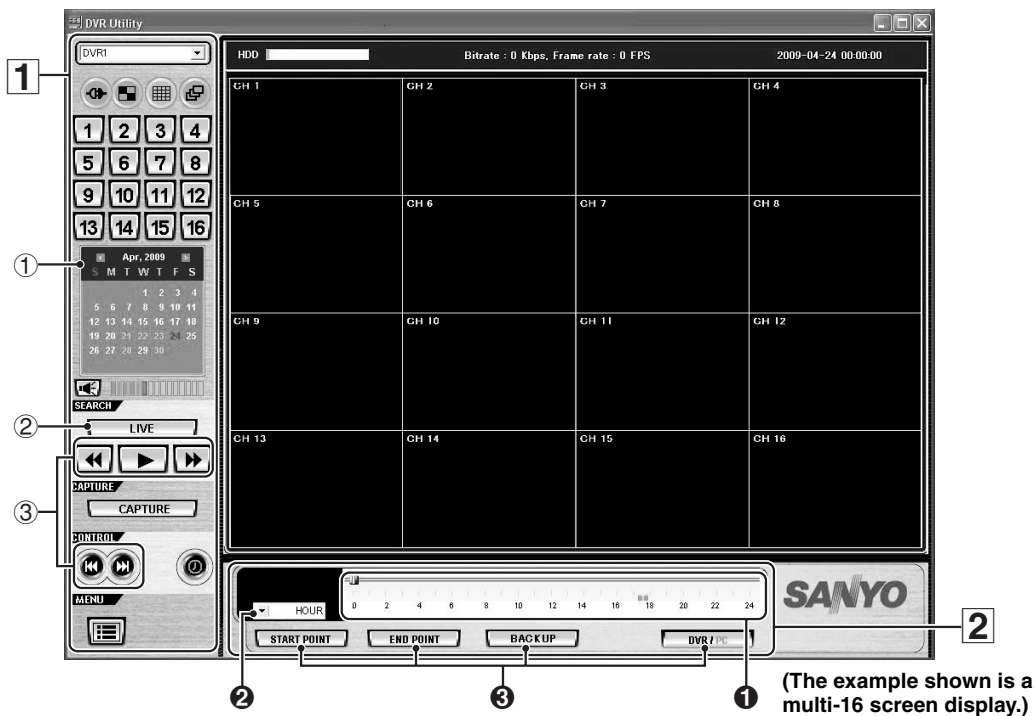

1 Function of the operation panel

When in search mode, the following operation button is displayed.

- ① **Calendar**
To specify the date and time of the video to be searched.
- ② **[LIVE] button**
To cancel the search mode and return to the live video.
- ③ **Playback operation button**
Plays back the searched video.
 - : Plays reverse playback / Fast rewinds
The playback speed switches each time the button is clicked. (x1, x2)
 - : Plays back
 - : Pauses and displays a still image
 - : Fast forwards
The playback speed switches each time the button is clicked. (x2, x4)
 - : Moves the paused video to the previous frame when the button is clicked.
When in playback, rewinds the video by one minute when the button is clicked.
 - : Advances the paused video to the next frame when the button is clicked.
When in playback, forwards the video by one minute when the button is clicked.

2 Functions of the time scale

The scale and backup operation button for the video search are displayed in place of the log window.

- ① **Time scale**
Moves the slide knob on the scale as the video is played back.
The playback point moves as the slide knob is dragged and dropped to the left or to the right or when clicking on the scale.
- ② **Display unit**
Switches the mark unit of the scale.
 - **HOUR:** One hour X 24 marks
 - **MINUTE:** 5 minutes X 12 marks
- ③ **Backup operation button**
 - **START POINT:**
Sets the start point of the video range to be backed up.
 - **END POINT:**
Sets the end point of the video range to be backed up.
 - **BACK UP:**
Executes the backup.
 - **DVR/PC:**
Switches the recorded video search destination (this unit or PC).

Search mode operations

A Searching and playing recorded video

Video recorded on this unit or on a PC can be searched and played using the date and time.

1 Select the search destination (DVR/PC).

Select whether to search the video recorded on the DVR (this unit) or the video recorded on the PC.

The search destination can be switched interchangeably by clicking [DVR/PC] on the time scale panel.



The search destination can be confirmed by looking at the button display.

- **DVR:**
Searches the video recorded on the DVR (this unit)
- **PC:**
Searches the video recorded on the PC

2 Click and specify the recorded date of the video to be searched on the calendar.

If a recorded video is available on the selected date, the date is displayed in red.



Clicking [◀] / [▶], switches the calendar display to the previous/next month.

3 Confirms the time slot with recorded video using the time scale.

A green line is displayed above the scale if a recorded video is available.

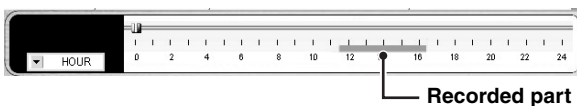

Memo: Switching the display unit of the scale from [HOUR] to [MINUTE] allows the user to further narrow down the time slot with recorded video.

4 Specify the playback start point.

Drag and drop the slide knob of the time scale and move it to the playback start point.

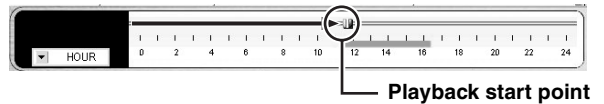

5 Click the playback button (①).

The video starts playing.

During the playback, the playback operation buttons allow such operations as fast forward, pause, and advance to the next frame. (P59)

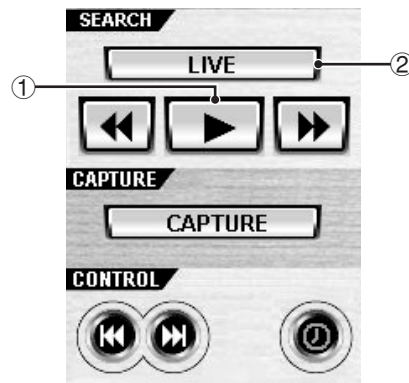

Memo:

- If no recorded video is available at the specified playback start point, the unit jumps to the next available recorded video and starts playing.
- As in the case of live video, the screen display mode can be switched using the operation panel buttons. (P55)
- Playback via network is not available while playing back with the unit.

6 To stop playback and return to live video.

Click [LIVE] (②) on the operation panel.

Switches to the live video and returns the displays, such as the operation panel display, to standard mode.

Search mode operations

B Backing up DVR recorded video

DVR (this unit) recorded video can be backed up on the hard disk of a PC in AVI format.

Search the recorded video by following the procedure below, specify the video range to be backed up and execute a back up.

Refer to steps 1-3 of "Searching and playing recorded video (P60)".

- 1 Specify the search destination (DVR/PC).**
Set to "DVR".
- 2 Click the calendar and specify the date of the video to be searched.**
- 3 Confirms the time slot with recorded video using the time scale.**
- 4 Specify the backup start point.**
Move the slide knob of the time scale to the start point and click [START POINT].
- 5 Specify the backup end point.**
Move the slide knob of the time scale to the end point and click [END POINT].
A dark green line is displayed on the specified video range.

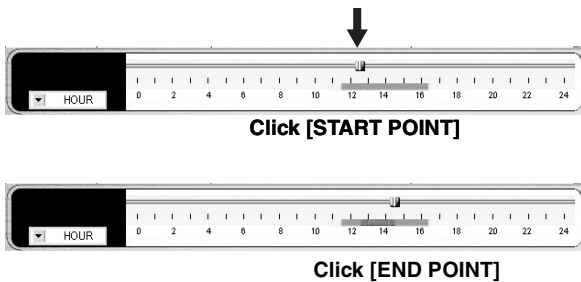

- Memo:**
- To undo the specified video range, re-click [START POINT].
 - If the specified video range is too short, it may be cancelled when [BACK UP] is clicked. In that case, specify a longer video range and click [BACK UP], then adjust it using the "AVI Backup" dialog.

- 6 Click [BACKUP].**
Check the channel selection box of the channels to be backed up in the "AVI Backup" dialog. The video of the specified channels are backed up sequentially, in the order of channel numbers.

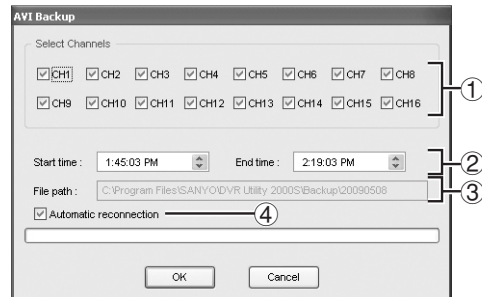

- 1 Select Channels:**
Check the channel selection box of the channel to be backed up.
However, channels without recorded video are skipped.
- In DSR-2108, CH1 - CH8.**
- 2 Start time/End time:**
Can be modified using the spin buttons.
- 3 File Path:**
The path set in the general settings screen in the set up menu is displayed. (P62)
- 4 Automatic reconnection:**
If the checkbox is checked, backup continues after reconnecting even if the network gets disconnected during backup.
If the checkbox is not checked, an error dialog is displayed. Select whether to continue or cancel.

- 7 Click [OK].**
The specified recorded video range is backed up on the PC. The backup progress is displayed in the progress gauge of the dialog.

- Memo:**
- **Destination folder name**
Input the date information of the first image of the video.
 - **Saved file name**
(Camera channel number) + time information of the first image
Example:
[CH1] 08_30_08 = Recorded video from camera 1 at 08h30m08s
 - Video is backed up in the AVI format and can be played using video playback software compatible with the AVI format such as Windows Media Player™.
If the video cannot be played with a standard AVI software, install FFDSHow (Codec) from the supplied CD-ROM. (P27)
Video recorded on the PC can also be backed up by specifying "PC" as the search destination. However, there are some limitations, such as the number of channels that can be backed up at any one time (limited to 1).

Setup menu settings

To display the "Setup" screen, click the menu button () on the operation panel. Set the settings concerning the operation conditions of the DVR (this unit) during connection and the network operations on this screen.

Clicking menu in the [Setup Menu] window on the left of the screen displays the specified menu screen.

A General settings (General)

Sets functions such as security functions, video data destination folder and starting automatic connection functions.

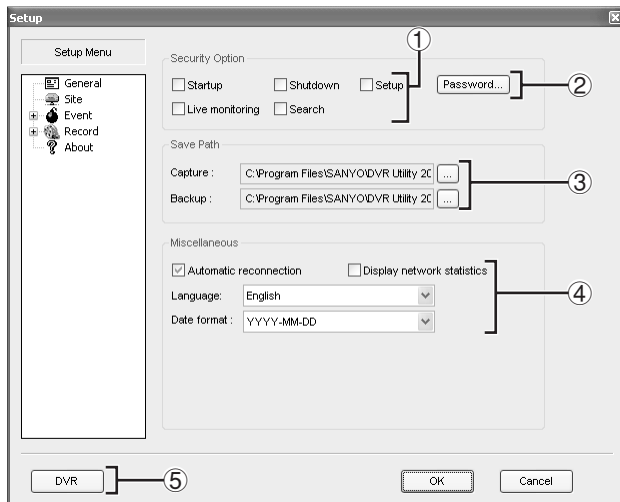

① Security Option

When a check is input in the checkbox, a password is necessary to perform each operation.

- **Startup:**
Starts the present software
- **Shutdown:**
Exits the present software
- **Setup:**
Displays the "Setup" screen
- **Live monitoring:**
Displays the live video
(Operation of the [LIVE] button on the operation panel)
- **Search:**
Switches the main screen to search mode
(Operation of the [SEARCH] button on the operation panel)

② Password

Clicking the button allows the user to set a [Security Option] password.

- **Old Password:**
Input the current password.
- **New Password:**
Input the new password.
- **Confirm Password:**
Re-input the new password to confirm the password.
Click [OK] after inputting the password.



③ Save Path

Set the destination folder for still video (Capture) and backup video (Backup).

④ Miscellaneous

• Automatic reconnection:

If the checkbox is checked, reconnection operations are performed automatically, after an interval of approximately 10 seconds, when the network is temporarily disconnected (NETWORK LOSS).

• Display network statistics:

If the checkbox is checked, the communication bit rate and frame rate of the network is displayed in the information display part of the main screen.

• Language:

Allows the user to select the display language.

• Time format:

Allows the selection of the date and time information display pattern.

☞ Click [OK] once the above settings are complete.

The content of the settings are confirmed and saved.

⑤ DVR (Remote setup)

Allows the user to perform settings of the DVR unit's menu from a PC, via network. See P66 - P75.

Setup menu settings

B Camera designation settings (Site)

The connection information registered in the "Connect" dialog at the time of connection is displayed as a list in the "Site" list.

Allows the user to add, change, delete the registered information or set a channel name.

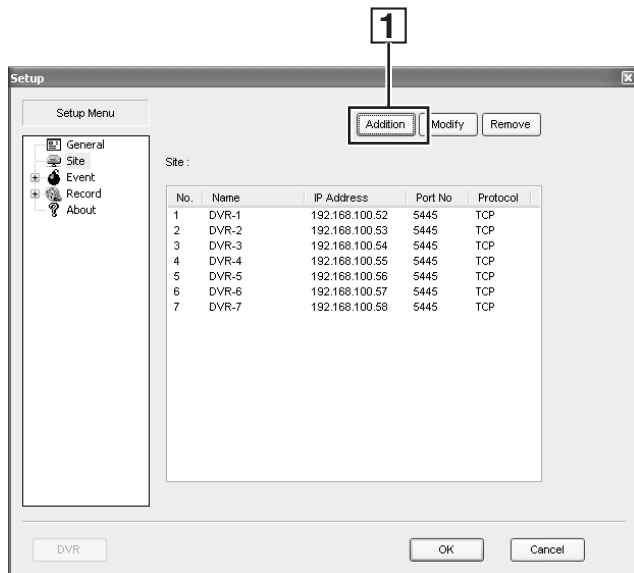

■ Registering the additional DVR (Addition)

- 1 Click "Addition".
The "Addition" dialog is displayed.

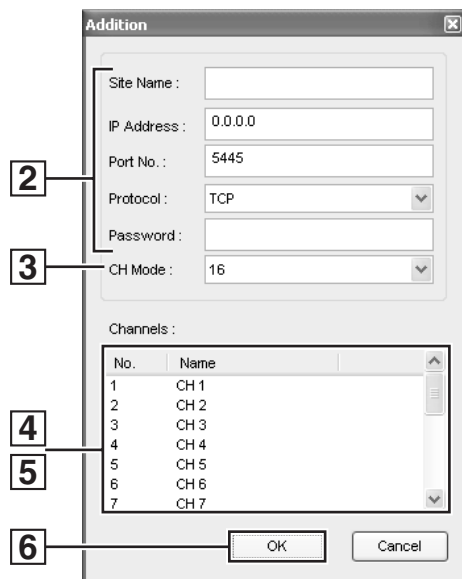

- 2 Input the information necessary to the connection such as the address.

The input method is the same as the one used for the "Connect" dialog at the first connection.

- **Site Name:** Name of the administrator
- **IP Address/Port No:** The IP address and port number set in the DVR
- **Protocol:** TCP/UDP
- **Password:** The network password set in the DVR

- 3 Select the number of channels on the DVR (4/8/16 CH) using the "CH Mode".

- 4 Click the channel in the "Channels" list and click again on the reversed blue display.

The input box is displayed.

- 5 Input the channel name.

The specified name is displayed on displays such as the camera video.

Set a channel name for each channel following the same procedure.

- 6 Click "OK".

The "Addition" dialog close and the site is added to the "Site" list.

■ Modify the registered content (Modify)

- 1 Click the site to be modified in the "Site" list.
The line of the selected site is highlighted in blue.

- 2 Click "Modify".

The "Modify" dialog is displayed.

- 3 Modifying the registered content displayed in the dialog.

- 4 Click "OK".

The "Modify" dialog shuts down and the "Site" list is updated.

Memo: No channel name is set when connected.

To set channel names use "Modifying registered content (Modify)".

■ Remove a registered site (Remove)

- 1 Select the site to be removed in the "Site" list.
The line of the selected site is highlighted in blue.

- 2 Click "Remove".

The "Remove" dialog close and the "Site" is removed from the "Site" list.

Click [OK] once the above settings are complete.
The content of the settings are confirmed and saved.

Setup menu settings

C Event settings (Event)

Sets the event management method.

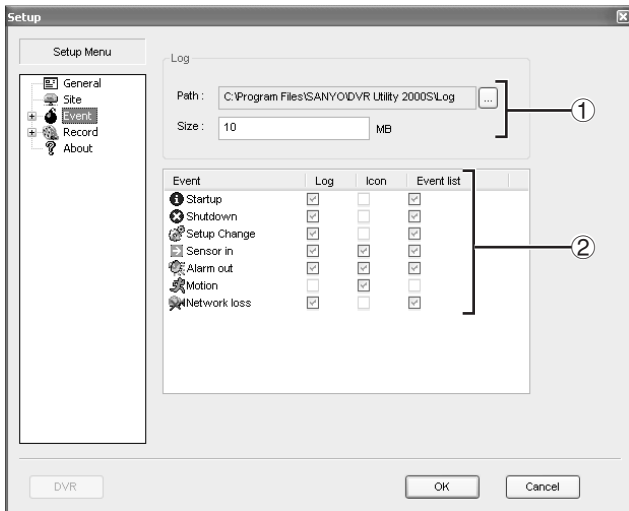

① Log

Sets the storage location and allowable size of the event log.

② Event

Set the saving and display conditions for each event using the checkbox.

- **Log:**
Whether it saves it as an event log or not
- **Icon:**
Whether it displays an icon on the camera video or not
- **Event list:**
Whether it displays the event on the log window of the main screen or not

Click [OK] once the above settings are complete. The content of the settings are confirmed and saved.

D Event log search, view, save (Log View)

Event information can be searched and events can be saved to a PC.

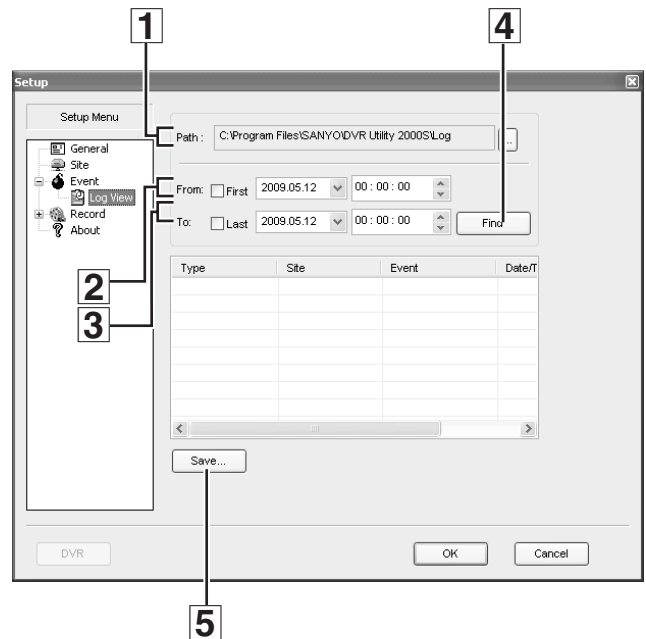

1 Specify the folder to be searched using [Path].

2 Set the start point of the search range in [From].
If the checkbox [First] is checked, it is automatically set to the first date and time in the folder.

3 Set the end point of the search range in [To].
If the checkbox [Last] is checked, it is automatically set to the newest date and time in the folder.

4 Click [Find].
The event information of the specified range is displayed as a list in the log list.

5 To save the displayed log list as text, click [Save].
To change the destination folder displayed in [Path], click [Browse] and select a new destination folder.

Once the above operations are complete, click [OK] and close the screen.

Setup menu settings

E Record settings (Record)

Sets the recording conditions while in network operations. Recorded video is saved on the hard disk of the PC.

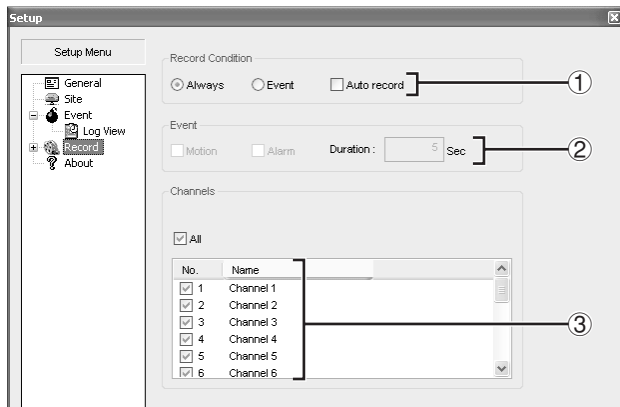

① Record Condition

Select a recording mode using the radio button.

- **Always:**
Recording is performed when the recording button on the operation panel is set to ON.
- **Event:**
When the recording button on the operation panel is set to ON, recording is on standby and recording is performed when specified events occur.

<Automatic recording settings (Auto Record)>

If the checkbox is checked, the recording button on the operation panel is set to ON and video is automatically recorded in the selected recording mode only after you launch the DVR Utility 2000S the next time.



[Auto Record] settings become valid as soon as the unit has been disconnected and reconnected.

② Event

If [Record Condition] is set to "Event", set the following conditions.

<Event types>

- **Motion:**
When this unit performs a MOTION recording the event is also recorded on the PC.
- **Alarm:**
When an alarm signal is input into the external sensor terminal situated on the back panel of this unit, the event is recorded on the PC.

<Recording duration>

- **Duration (Unit: seconds)**

③ Channel

Specify the camera to be recorded using the checkbox.

Memo: Using "All" of the checkbox, the user can check or uncheck all the cameras.

Click [OK] once the above settings are complete. The content of the settings are confirmed and saved.

F Disk settings (Disk)

Set the capacity and the drive of the PC where the recorded video is saved.

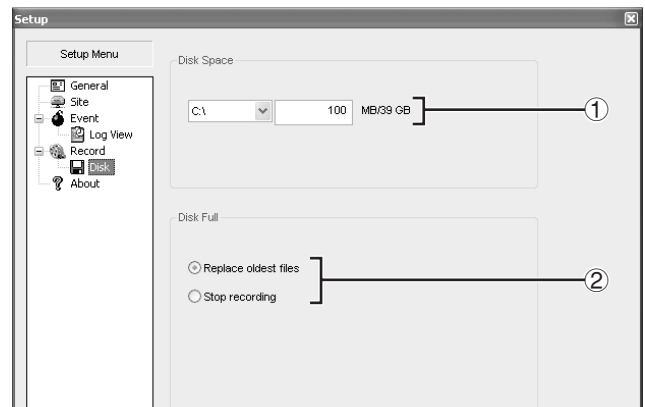

① Disk Space

Select the drive used for saving and input the allowable capacity (MB).

② Disk Full

Select the option once the capacity is exceeded using the radio button.

- **Replace oldest files:**
Continues to record and overwrites the previously recorded video starting with the oldest.
- **Stop recording:** Stops the recording.

Click [OK] once the above settings are complete. The content of the settings are confirmed and saved.

G Version information (About)

The version information of the currently used software can be confirmed.

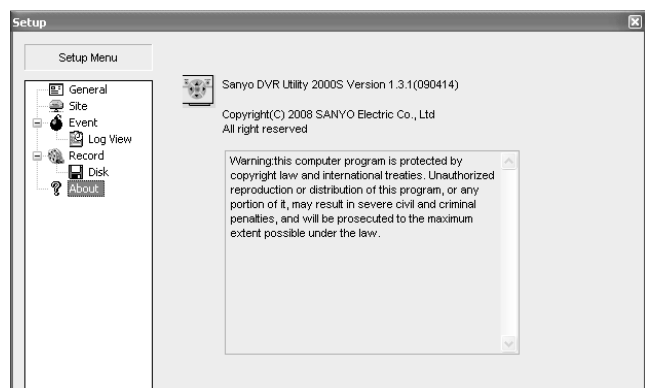

Remote Setup

The menu settings for the DVR unit can be set from a PC, via network.

A Remote Setup operating procedure

- 1 Click the **MENU** button on the operation panel.
The [Setup] screen is displayed.

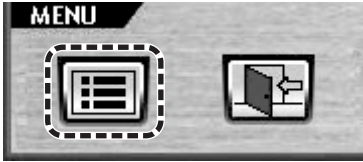

- 2 Click **[DVR]** at the lower left of the screen.
The [Remote Setup] screen is displayed.

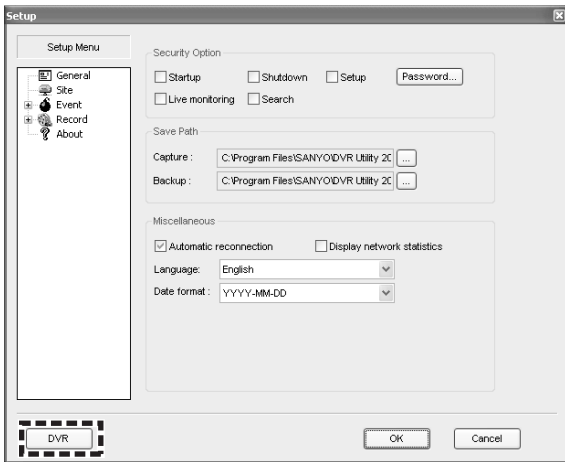

Memo: Remote setup may not be supported depending on the DVR model. In that case, clicking [DVR] will display an error message.

- 3 Select and click the menu item to set from the tree list.

The specified menu screen is displayed.

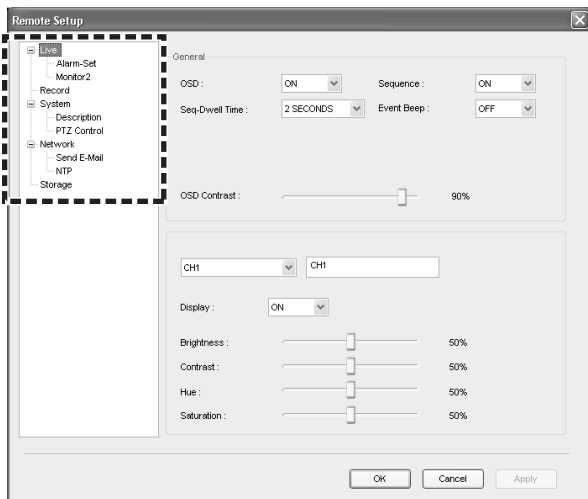

- 4 Set the menu item displayed on the screen.
Setting is basically the same as with the DVR menu setting.
Refer to the corresponding pages for details on the setting items.

- 5 Click **[Apply]** or **[OK]**.
The "**Remote-Setup Success**" message is displayed on the [Success] dialog and the setting sent to the DVR.
Click **[OK]** and close the dialog.

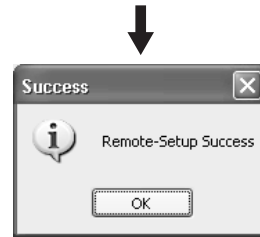
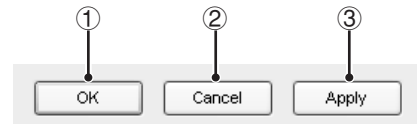

- 1 **Clicking [Apply]:**
The [Remote Setup] screen remains displayed even after the [Success] dialog is closed.
Close the [Remote Setup] screen by clicking [OK] upon completing all of the remote setup operations.
- 2 **Clicking [OK]:**
Closing the [Success] dialog also closes the [Remote Setup] screen.
- 3 **Clicking [Cancel]:**
If a setting value has been changed on the screen, a dialog confirming whether to save or not the changes is displayed.

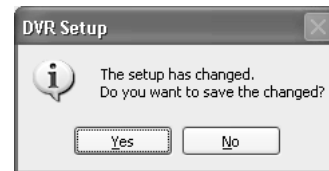

- Selecting [No] returns the setting to the previous value and closes the [Remote Setup] screen.
Clicking [Yes] displays the "**Remote-Setup Success**" message on the [Success] dialog and sends the settings to the DVR.
Closing the [Success] dialog also closes the [Remote Setup] screen.

Remote Setup

B Setting the Display

To set the live video display conditions.

Common settings (General)

These settings apply to all channels.

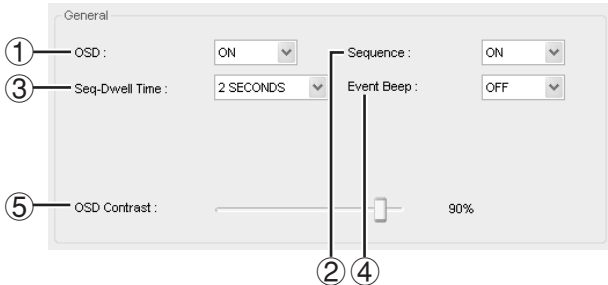

① OSD

Sets whether to display or not date and time as well as channel number on the screen.

- **ON:** Display
- **OFF:** Do not display

② Sequence

Setting for automatically switching the displayed video. Displays the video of the connected cameras on a single-screen or quad-screen display sequentially, in the order of channel numbers.

- **ON:** Automatic sequencing enabled
- **OFF:** Automatic sequencing disabled

③ Seq-Dwell Time

Sets the interval (1 - 60 SECONDS) for automatically switching the screens.

④ Event Beep

Setting for sounding an alarm in the event of an alarm.

- **ON:** Alarm sound enabled
- **OFF:** Alarm sound disabled

⑤ OSD Contrast

Adjusts the character contrast on the screen.

Channel-specific settings

These settings apply to the specified channel only.

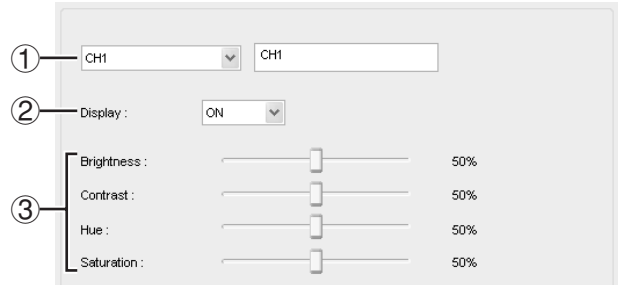

① Channel designation (CH1 - CH16)

In DSR-2108, CH1 - CH8.

② Display

Sets whether to display or not video from the channel on the monitor.

- **ON:** Display
- **OFF:** Do not display

③ Video image adjustment

- **Brightness:** Adjusts the brightness.
- **Contrast:** Adjusts the contrast.
- **Hue:** Adjusts the hue.
- **Saturation:** Adjusts the saturation.

Remote Setup

C Setting the Alarm-Set

To set the alarm input/output conditions of the alarm input/output terminals.

■ Alarm Out

Sets whether to output or not alarm signal from this unit.

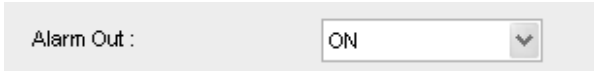

- **ON:** Output enabled
- **OFF:** Output disabled

■ Setting an alarm output terminal

Specify an alarm output terminal number (1 - 4) and set the alarm output conditions.

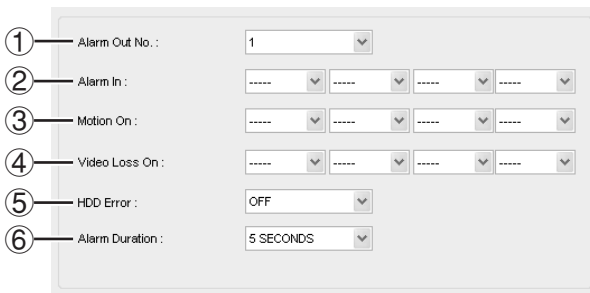

① Alarm Out No.

Specifies the alarm output terminal number (1 - 4).

② Alarm In

Outputs an alarm signal when the specified external alarm input terminal receives an input.

Input terminal number

DSR-2116: 1 -16, DSR-2108: 1 - 8

③ Motion ON

Outputs an alarm signal when the specified video input terminal receives a motion detection signal.

Input terminal number

DSR-2116: 1 -16, DSR-2108: 1 - 8

④ Video Loss On

Outputs an alarm signal when a video loss occurs in the specified video input terminal.

Input terminal number

DSR-2116: 1 -16, DSR-2108: 1 - 8

⑤ HDD Error

Sets whether to output or not an alarm signal when a hard disk error occurs.

- **ON:** Alarm signal output enabled
- **OFF:** Alarm signal output disabled

⑥ Alarm Duration

Sets the duration of the alarm output signal.
(3 - 255 SECONDS)

■ Setting an alarm input terminal

Specify an alarm input terminal number and set the type.



① Alarm In No.

Specifies the alarm input terminal number.

Input terminal number

DSR-2116: 1 -16, DSR-2108: 1 - 8

② Type

Sets the signal polarity of the specified alarm input terminal.

- **----**: Alarm input detection disabled
- **N/O (Normal Open):**
Normally open, detects input when closed
- **N/C (Normal Close):**
Normally closed, detects input when opened

Remote Setup

D Setting the Monitor2

To set the output conditions of the monitor video terminal (MON2).

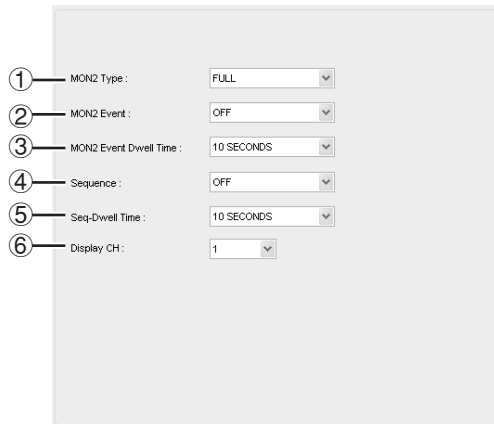

① MON2 Type

Sets the output screen layout of the MON2 terminal.

- **FULL:** Single-screen output
- **QUAD:** Quad-screen output

② MON2 Event

Sets whether to output or not the video of an ALARM recording to MON2 while it is being recorded.

- **ON:** Output of ALARM recording video enabled
- **OFF:** Output of ALARM recording video disabled

③ MON2 Event Dwell Time

Sets the output duration of the ALARM recording video. (1 - 10 SECONDS) if "**MON2 Event**" is set to ON.

④ Sequence

Sets whether to automatically switch or not the video output to MON2 terminal.

- **ON:** Automatic switch enabled
- **OFF:** Automatic switch disabled

⑤ Seq-Dwell Time

Sets the video switching interval (1 - 10 SECONDS) if "**Sequence**" is set to ON.

⑥ Display CH

Sets the channel that outputs video to the MON2 terminal.

<If "Sequence" is set to OFF>

If "**MON2 Type**" is set to "**FULL**", sets one channel, and if it is set to "**QUAD**", sets 4 channels.

Channel:

DSR-2116: 1- 16, DSR-2108: 1 - 8

<If "Sequence" is set to ON>

Check the channel selection box of the desired channel.

Channel:

DSR-2116: 1- 16, DSR-2108: 1 - 8

Remote Setup

E Setting the Record

To set the recording conditions.

■ Resolution (Common to all channels)

Sets the resolution for the recordings.

The set value applies to all channels.

Resolution :

- QUAD
- FULL
- HALF

■ Channel-specific settings

These settings apply to the specified channel only.

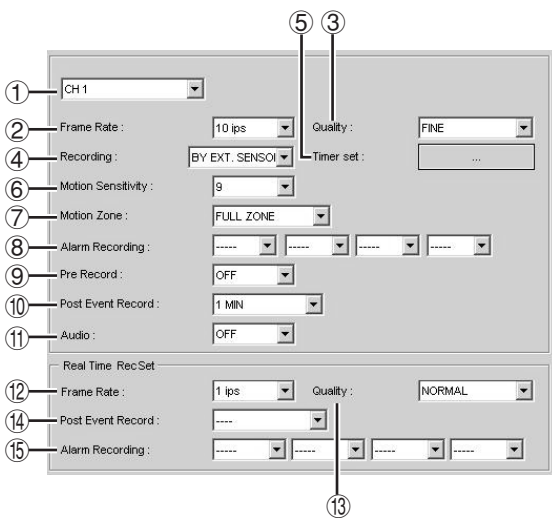

① Channel designation

Channel

DSR-2116: 1 -16, DSR-2108: 1 - 8

② Frame Rate

Sets the recording rate.

(OFF, NTSC: 1 - 30 ips/PAL: 1 - 25 ips)

③ Quality

Sets the image quality in 5 levels (NETWORK/ECONOMY/BASIC/NORMAL/FINE).

④ Recording

Sets the recording mode.

- **DISABLE:** Recording disabled.
- **CONTINUOUS:** Recording is performed while the DVR is on.
- **BY MOTION:**
Recording is performed when the motion sensor built into this unit detects a movement.
- **BY EXT. SENSOR:**
Recording is performed when a sensor connected to an external alarm input terminal (ALARM IN) of this unit reacts.
- **BY SCHEDULE:**
Recording is performed at the time slots specified in the schedule.

⑤ Timer Set

Sets the schedule for SCHEDULE recording using the [Schedule] screen. (Refer to P71 for information about the setting procedure)

⑥ Motion Sensitivity

Sets the level of detection sensitivity (1 - 9) of the motion sensor.

The lower the value, the higher the detection sensitivity.

⑦ Motion Zone

Sets the zone where the motion sensor is active.

A detection frame needs to be set when "PARTIAL ZONE" is selected. (Refer to P71 for information about the setting procedure)

- **FULL ZONE:** The motion sensor is active on the whole screen.
- **PARTIAL ZONE:** The motion sensor is active in a set detection frame.

⑧ Alarm Recording

ALARM recording is performed when an external alarm signal is input to the specified external alarm input terminal

Input terminal

DSR-2116: -----, 1 -16

DSR-2108: -----, 1 - 8

⑨ Pre Record

Sets whether to perform or not pre-ALARM recording.

When enabled, recording is started approximately 5 seconds before the internal motion sensor or the external sensor detector is triggered.

- **ON:** Pre-ALARM recording enabled
- **OFF:** Pre-ALARM recording disabled

⑩ Post Event Record

Sets the duration of the ALARM recording (2 - 30 SECONDS, 1 - 5 MINUTES, 10 MINUTES, 15 MINUTES).

⑪ Audio

Sets whether to perform or not audio recording.

- **ON:** Recording of audio of live video enabled
- **OFF:** Recording of audio disabled

⑫ Real Time Frame Rate

Sets the recording rate.

(OFF, NTSC: 1 - 30 ips/PAL: 1 - 25 ips)

⑬ Quality

Sets the image quality for real-time recording in 5 levels (NETWORK/ECONOMY/BASIC/NORMAL/FINE).

⑭ Post Event Record

Sets the duration of the real-time recording (--, 2 - 30 SECONDS, 1 - 5 MINUTES, 10 MINUTES, 15 MINUTES)

Memo: If "--" is selected, recording is triggered when the Record/Stop button is pressed or whenever an alarm input occurs.

⑮ Alarm Recording

Sets the alarm input terminal number that triggers real-time recording.

Input terminal

DSR-2116: -----, 1 -16

DSR-2108: -----, 1 - 8

Remote Setup

■ Setting the detection frame

Set the zone where the motion sensor will be active.

- 1 Set [Motion Zone] to "PARTIAL ZONE".**
A button is displayed to the right.



- 2 Click the button.**
The screen for setting the detection frame is displayed.

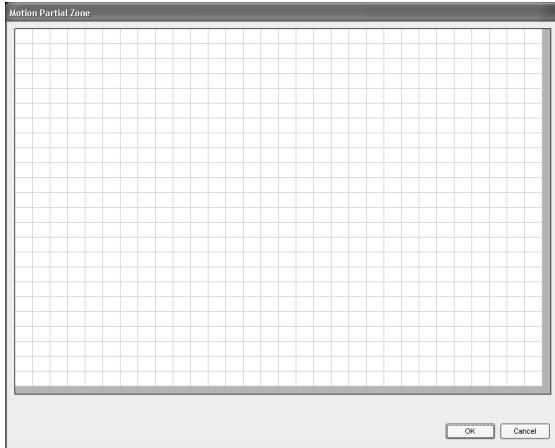

- 3 Click (or drag) a grid cell in the desired detection frame.**

The sensor is set in the specified frame.

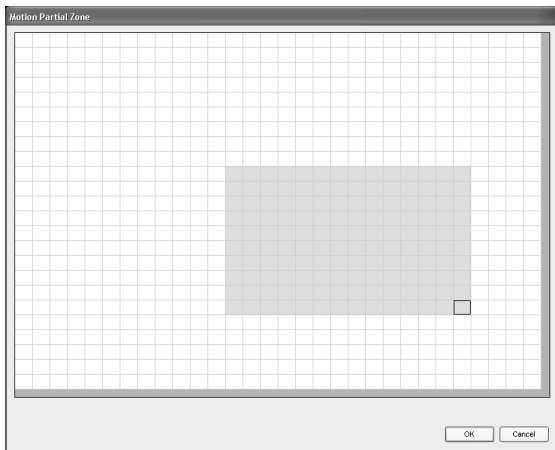

- 4 Click [OK].**
The contents of the setting are saved and the screen for setting the detection frame closed.

■ Setting the SCHEDULE recording

Set the schedule for the SCHEDULE recording.

- 1 Click the [Timer Set] button.**
The [Schedule] screen is displayed.

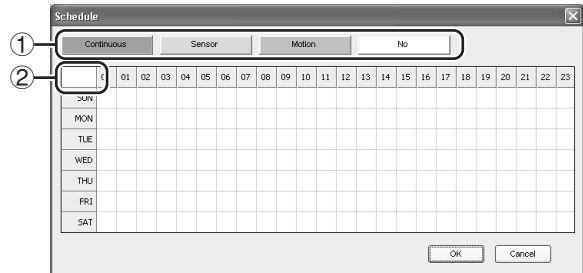

- 2 Select a recording mode button ① and click it.**
The selected recording mode is displayed in colour at the upper left corner of the schedule ②.

- 3 Specify the day of the week and time slot, and click (or drag) the grid cell of the schedule.**

Recording is scheduled for the specified time slot. Multiple recording modes can be combined using the same procedure.

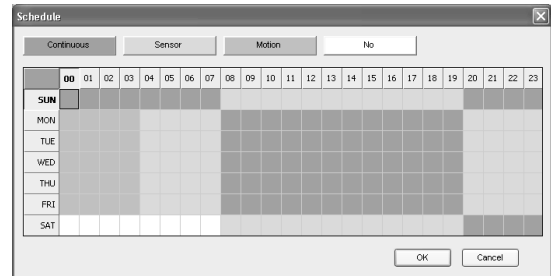

Memo: To schedule the selected recording mode for all of the time slots (24 hours) of a day, click the button of the day of the week.

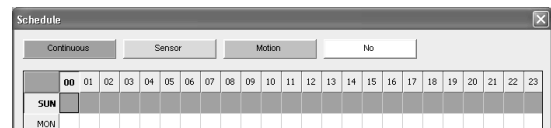

- 4 Click [OK].**
The contents of the setting are saved and the [Schedule] screen closed.

Remote Setup

F System settings

Settings related to the system and time.

Setting the System

- ① **DVR ID (P37)**
Sets individual designation to DVRs.
- ② **Admin Password (P38)**
This is a password for performing menu settings on the DVR unit.
Memo: The default value is "1111".
- ③ **User Password (P39)**
This setting is used to give controlled operational access to administrators and general users. The operations with User Password are limited to search and playback.
Memo: No user password is set by factory default.
- ④ **Network Password (P39)**
This password is for limiting the access to the network.
Memo: The default value is "1111".
- ⑤ **Date Format (P9)**
Sets the date display format.
- ⑥ **Language (P11)**
Sets the display language.
- ⑦ **Remote Controller (P41)**
Allows to set an ID number (1 - 99) on the supplied remote control for its identification.

Memo: If set to the default value (0), no ID number is necessary for performing remote operations.

Clock Set

- ① **Set Date & Time (P9)**
Sets the current date and time.
- ② **D.S.T./SUMMER TIME (P10)**
Sets whether daylight saving is applicable or not.
 - **OFF:** Daylight saving not applicable
 - **U.S.A.:** USA daylight saving time applicable
 - **EU:** EU daylight saving time applicable
Select the GMT Area.
(+00:00 to +05:00)
 - **OTHER:** Allows to set the start and end dates of the daylight saving period for time zones other than USA and EU.
(Begin/End)

Memo: A confirmation dialog is displayed when [Apply] (or [OK]) is clicked if the date and/or time settings have been changed.
The DVR is restarted and the date and time updated when [YES] is clicked on the confirmation dialog.



Remote Setup

G Description

This sub menu is accessible from the System settings. Allows to check information on the DVR such as the version information.

The screenshot shows a 'Description' menu with the following fields and values:

HW Version :	10.3.3
S/W Version :	SNI624CF.69.MANJAL(20090421)
Storage Size :	761 GB (780096 MB) / 2.HDD
IP Address :	192.168.100.52
MAC Address :	00:02:69:03:3e:97
Time Count :	431 h
HDD A USE TIME :	424 h
HDD B USE TIME :	7 h

- **H/W Version**
- **S/W Version**
- **Storage Size:** Hard disk capacity
- **IP Address**
- **MAC Address**
- **Time Count**
- **HDD A USE TIME:** Master hard disk
- **HDD B USE TIME:** Slave hard disk (expansion)

H Setting the PTZ Control

This sub menu is accessible from the System settings. Allows to set the communication environment for remotely operating PTZ dome cameras connected to RS485 terminals.

PTZ Control

The screenshot shows the 'PTZ Control' menu with the following fields and values:

① DATA SPEED :	9600
② CH :	CH 1
③ Protocol :	----
④ Address :	1

- ① **DATA SPEED**
Sets the communication speed. The set value applies to all channels.
- ② **Camera channel designation**
- ③ **Protocol**
Sets the protocol type for the specified channel.



When connecting multiple cameras, set the same protocol for all.

- ④ **Address**
Sets the camera ID (0 - 63).

RS-485

Set when connecting a system controller or cameras using SANYO protocol.

The screenshot shows the 'RS485' menu with the following fields and values:

① DATA SPEED :	9600
② Address :	1

- ① **DATA SPEED**
Sets the RS-485 communication speed (2400/4800/9600/19200).
- ② **Address**
Sets the address (0 - 128) of the RS-485 control terminal.

Remote Setup

I Setting the Network

To set information about the DVR network.

 **The DVR will be forcibly restarted if a value on this screen is changed.**

■ Network settings

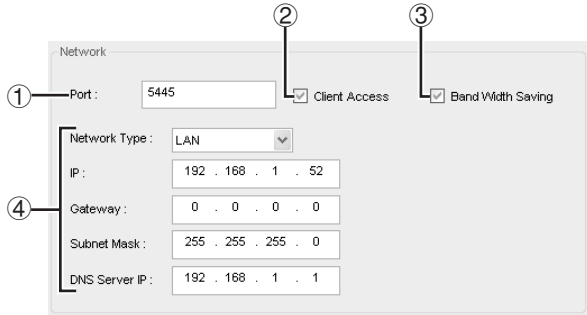

The screenshot shows the 'Network' configuration screen. Callout 1 points to the 'Port' field (5445). Callout 2 points to the 'Client Access' checkbox (checked). Callout 3 points to the 'Band Width Saving' checkbox (checked). Callout 4 points to the 'Network Type' dropdown menu (set to LAN). Below the dropdown are fields for IP (192.168.1.52), Gateway (0.0.0.0), Subnet Mask (255.255.255.0), and DNS Server IP (192.168.1.1).

① Port

When connecting multiple DVRs to the network, set a unique port number to each DVR.

② Client Access

To operate via network, make sure the checkbox is checked.

③ Band Width Saving

To limit the network bandwidth, check the checkbox.

④ Address settings

Input necessary information depending on the selected [Network Type].

• If "LAN" is selected:

The address setting mode is manual.
Input IP, Gateway, Subnet Mask, and DNS Server IP.

• If "DHCP" is selected:

The address setting mode is automatic.
Addresses and other information do not need to be set.

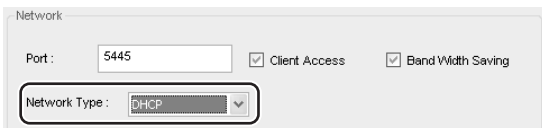

The screenshot shows the 'Network' configuration screen with 'Network Type' set to 'DHCP'.

• If "ADSL" is selected:

Input the login ID and Password.



The screenshot shows the 'Network' configuration screen with 'Network Type' set to 'ADSL'. Below the dropdown are fields for 'ID' and 'Password'.

■ DDNS settings

When using Sanyo's DDNS service, select "SANYO" and input the registered domain name.



The screenshot shows the 'DDNS' configuration screen. The 'SANYO' dropdown is selected, and there is an empty text field for 'DDNS SERVER SET'.

- Memo:**
- Refer to P45 for details on how to register the domain name.
 - When using other company's DDNS service, contact the dealership where this unit was purchased or a "Repair Service Center".

Remote Setup

J Setting the Send E-Mail

This sub menu is accessible from the Network settings.
 This setting is used to automatically send a notification e-mail to a specified address when an alarm occurs, for example.



The DVR will be forcibly restarted if a value on this screen is changed.

- ① **Send E-mail**
 - **ON:** E-mail sending function enabled
 - **OFF:** E-mail sending function disabled
- ② **IP Notification**
 To send a notification e-mail when the DVR IP address is changed, check the checkbox.
- ③ **Event Alarm**
 The alarm event type can be used as condition for sending notification e-mails.
 - **OFF (factory default)**
 Notification e-mail is not sent even if an alarm is detected.
 - **ALARM**
 A notification e-mail is sent when ALARM recording is triggered by the sensor connected to the external alarm input terminal (ALARM IN) of the unit.
 - **MOTION**
 A notification e-mail is sent when MOTION recording is triggered by a movement detected by the motion sensor built into the unit.
 - **ALL**
 A notification e-mail is sent when a recording is triggered either by an external alarm or the built-in motion sensor.

Memo: Alarm notification requires setting of ALARM-SET. (P32)

- ④ **Mail Address**
 Input the destination address.
- ⑤ **Mail Server settings**
 Input the SMTP server name as well as the user ID and password.
- ⑥ **RETURN MAIL ADDRESS**
 Set the source e-mail address to be notified to the destination.

K Setting the NTP

Allows synchronizing the time using an internet or LAN NTP server.

- ① **NTP USE**
 - **ON:** Synchronize using NTP server
 - **OFF:** Do not synchronize using NTP server
- ② **NTP Primary Server Address**
 Input the NTP primary server address.
- ③ **NTP Secondary Server Address**
 Input the NTP secondary server address.
- ④ **Time Zone**
 Select the time zone.
 (GMT -1:00 to -12:00, GMT 0:00 to 13:00)
- ⑤ **Interval**
 Set the time to synchronize.
 (01 - 24:00)

L Setting the Storage

Allows to configure continued recording settings by overwriting the hard disk and the storage period for the recording data.

- ① **Overwrite**
 To continue recording by overwriting when the hard disk becomes full, check the checkbox.
- ② **Auto Delete**
 - **ON:** Auto-delete function enabled
 - **OFF:** Auto-delete function disabled
- ③ **Auto Delete Days**
 If auto-delete is set to ON, set a recording data storage period.
 (2/3/4 - 60 DAYS)

Operations using the Web browser

Supported browsers are Internet Explorer 5.5 SP2 or later. Supported OSs are Windows XP and Vista.

- 1 Start the Web browser (Internet Explorer).
- 2 Input the URL.
Input the IP address of the hard disk digital recorder in the browser's address bar.

Input example:

- 3 Input the password in the Web Page Dialog. (Authentication check)

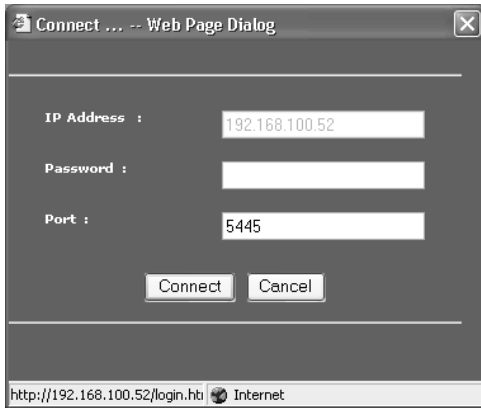

The factory default password is "1111". The password can be changed in NETWORK PASSWORD in the SYSTEM settings screen.

- 4 Click the [Connect] button.
Clicking [Cancel] closes the Web browser's screen.
- 5 The Web Page Dialog is closed and operation from the Web browser is enabled.

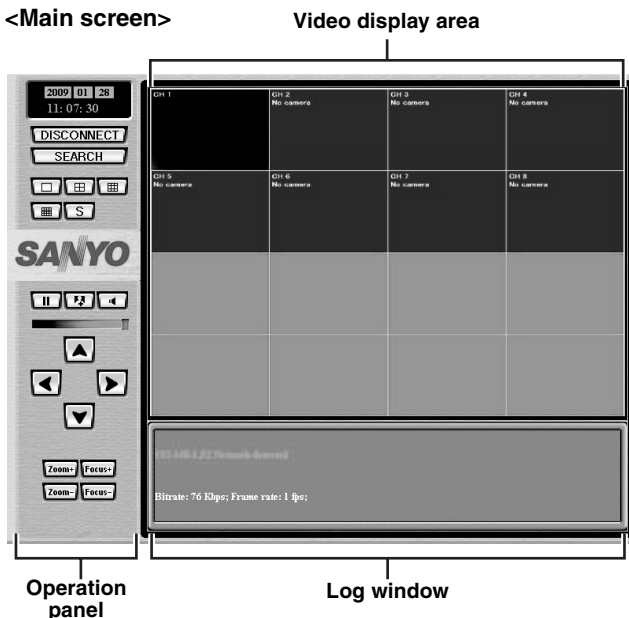

Functions of the main operation panel

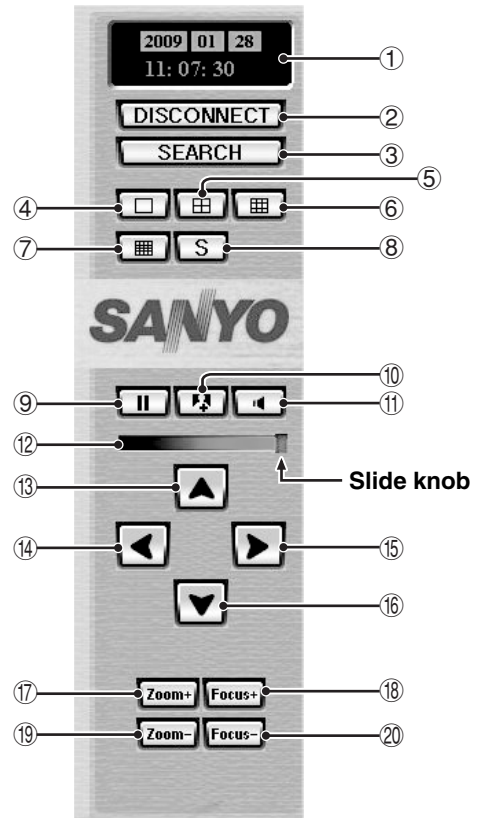

- 1 Live video date and time display
- 2 [DISCONNECT] button
Closes the Web browser's screen.
- 3 [SEARCH] button
Switches the screen to search mode. (P77)
- 4 Single-screen display button
- 5 Quad-screen display button
Each time the button is clicked, the displayed videos switch sequentially in units of 4 channels.
- 6 Multi-9 screen display button
In DSR-2116, each time the button is clicked, the displayed videos switch sequentially in units of 9 channels.
- 7 Multi-16 screen display button
In DSR-2116, each time the button is clicked, the displayed videos switch sequentially in units of 16 or 9 channels (2 patterns).
- 8 Sequence (camera sequencing) button
Available in single- or quad-screen display.
- 9 Still button
Freezes the live video displayed on the PC.
- 10 Capture button
Saves to PC a still image from the live video selected by clicking on it, shown with a red frame around it. (P78)
- 11 Audio ON/OFF button
- 12 Audio volume
To adjust the audio output of live videos, drag and drop the slide knob.

Operations using the Web browser

- ⑬ Tilt Up button
- ⑮ Pan Right button
- ⑰ Zoom In button
- ⑲ Zoom Out button
- ⑭ Pan Left button
- ⑯ Tilt Down button
- ⑱ Focus Near button
- ⑳ Focus Far button

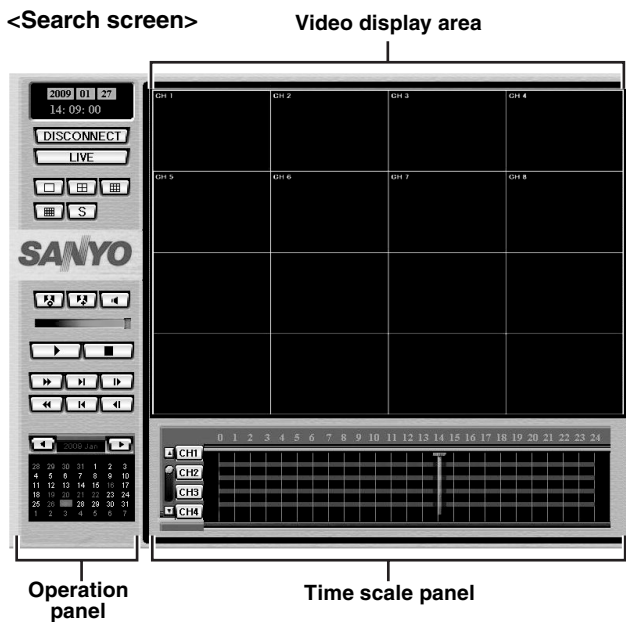

Functions of the search operation panel

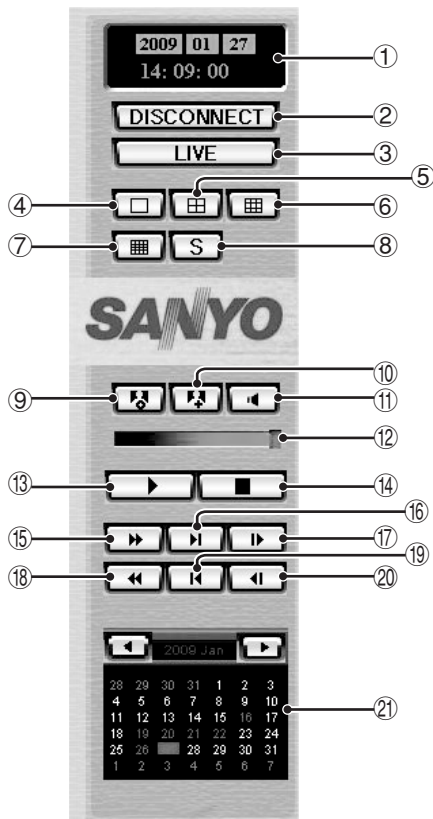

- ① Playback video/Still image date and time display
- ② [DISCONNECT] button
Closes the Web browser's screen.
- ③ [LIVE] button
Switches the screen to live mode.
- ④ Single-screen display button

- ⑤ Quad-screen display button
Each time the button is clicked, the displayed videos switch sequentially in units of 4 channels.
- ⑥ Multi-9 screen display button
In DSR-2116, each time the button is clicked, the displayed videos switch sequentially in units of 9 channels.
- ⑦ Multi-16 screen display button
In DSR-2116, each time the button is clicked, the displayed videos switch sequentially in units of 16 or 9 channels (2 patterns).
- ⑧ Sequence (camera sequencing) button
Available in single- or quad-screen display.
- ⑨ Download button
Saves to PC a moving video from the live video selected by clicking on it, shown with a red frame around it. (P78)
- ⑩ Capture button
Saves to PC a still image from the live video selected by clicking on it, and shown with a red frame around it. (P78)
- ⑪ Audio ON/OFF button
- ⑫ Audio volume
To adjust the audio output of a video being played back, drag and drop the slide knob.
- ⑬ Play/Pause button
- ⑭ Stop button
- ⑮ Fast-forward button
- ⑯ Skip button
Forwards the video by 1 minute when pressed during playback.
- ⑰ Skip Frame button
Moves the video to the next frame when pressed during pause.
- ⑱ Rewind button
- ⑲ Replay button
Rewinds the video by 1 minute when pressed during playback.
- ⑳ Replay Frame button
Moves the video to the previous frame when pressed during pause.
- ㉑ Calendar
Specifies the date of the video to be searched.
Select the month using the ◀ ▶ button. Clicking the date to be searched turns the background of the date to gray.
Dates in blue are dates for which there is recording data.
To check for time slots with recording data (green line), display the channel to be searched using the ▲ ▼ button on the time scale panel.
To playback the searched video, using drag and drop, move the slide knob of the time scale to the time to be played back and click the Play button.

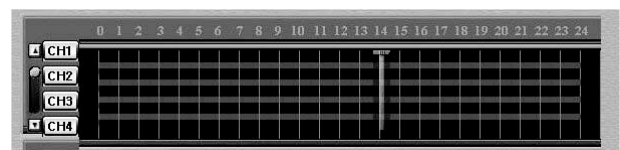

Slide knob

Operations using the Web browser

■ Saving still images to the PC

- 1 Click the Capture button.**
The Web Page Dialog is displayed.

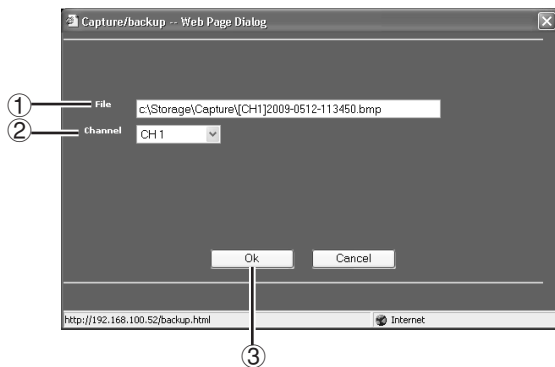

- 2 Select the [Channel] ② to be saved.**

- 3 Click the [OK] ③ button.**
A still image of the selected channel is saved to the folder specified in [File] ①.

Memo:

- The storage location is set in the general settings screen in the setup menu.
- The Web browser's (IE) Protected Mode must be turned off.

■ Saving moving videos to the PC

- 1 Click the Download button.**
The Web Page Dialog is displayed.

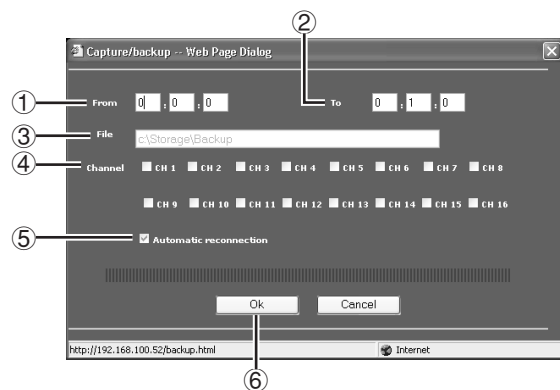

- 2 Set the starting time [From] ① and end time [To] ② of the moving video to be saved.**

- 3 Check the [Channel] ④ checkbox of the moving video to be saved.**

- 4 Click the [OK] ⑥ button.**
The moving video of the selected channel is saved to the folder specified in [File] ③.

Memo:

- The storage location is set in the general settings screen in the setup menu.
- If [Automatic reconnection] ⑤ is checked, backup continues after reconnecting even if the network gets disconnected during backup.
- The Web browser's (IE) Protected Mode must be turned off.

Part names of the remote control

Batteries for the remote control are not supplied. Use two AAA batteries.

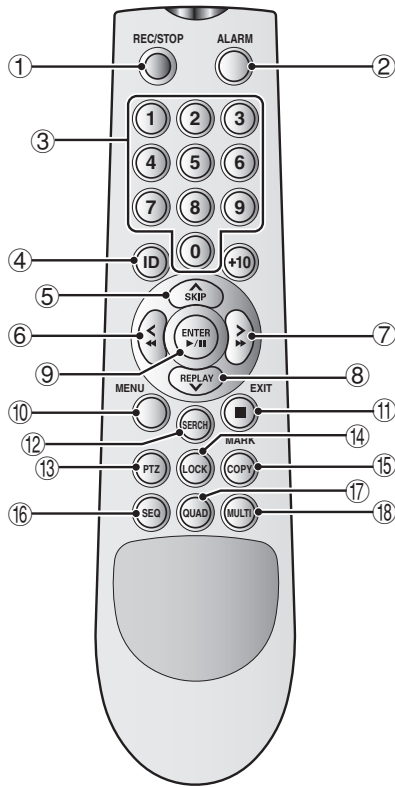

■ Inserting batteries in the remote control.

1 Take the battery cover off.

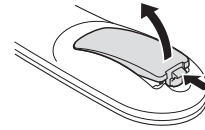

2 Place the batteries and fit the cover.

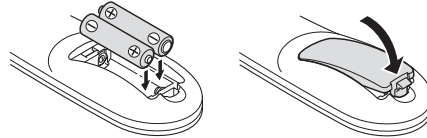

Note: Make sure the batteries are correctly oriented.

■ Operation range

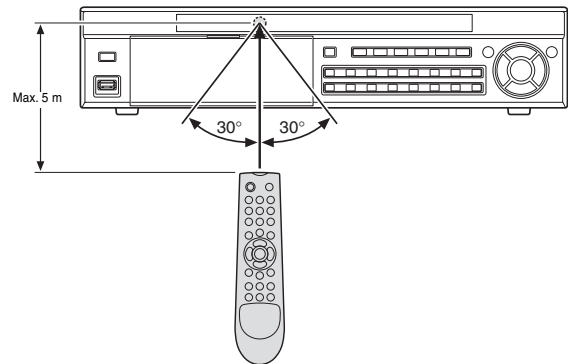

① REC/STOP button

Stops and starts recording of live videos displayed on the monitor.

② ALARM button

Switches ALARM OUT to ENABLE/DISABLE.

③ Numeric buttons

Used to input passwords, camera number and ID number.

④ ID button

If a remote control ID number was set, press before inputting it. (P41)

⑤ ▲ • SKIP button

During settings: Moves the cursor upward.

During playback: Skips the video 1 minute forward.

⑥ ◀ • ◀◀ button

During settings: Moves the cursor to the left.

During playback: Fast rewinds.

⑦ ▶ • ▶▶ button

During settings: Moves the cursor to the right.

During playback: Fast forwards.

⑧ REPLAY • ▼ button

During settings: Moves the cursor downward.

During playback: Skips the video 1 minute backward.

⑨ ENTER • ▶/|| button

During settings: Confirms the selected item.

During search: Plays back the selected video.

During playback: Displays a still video.

⑩ MENU button

Displays the setting menu screen.

⑪ EXIT button (■)

To exit the settings mode and the menu screen.

⑫ SEARCH button

Activates the recorded videos search mode.

⑬ PTZ button

Activates the operation mode that operates the Pan/Tilt/Zoom/Focus of PTZ dome cameras.

⑭ LOCK button

Switches security lock to ON/OFF.

⑮ MARK • COPY button

Activates the video saving mode.

⑯ SEQ button

Sequences the videos of the connected cameras.

⑰ QUAD button

Displays the quad-screen.

Each time the button is clicked the video of the next four channels is displayed in order of the channel numbers.

⑱ MULTI button

Displays a multi-screen.

Specifications

Signal method		Conforms to the NTSC/PAL system <ul style="list-style-type: none"> • NTSC: 60 ips • PAL: 50 ips
Compression method		Video: MPEG4, Audio: G.711
Number of pixels		NTSC: 704×480, PAL: 704×576
Live display	Speed	NTSC: 30 ips PAL: 25 ips
	Resolution	NTSC: 704×480 (FULL) PAL: 704×576 (FULL)
	Split-screen	DSR-2116: Single-screen/Quad-screen/Multi-9 screen/Multi-16 screen DSR-2108: Single-screen/Quad-screen/Multi-8 screen
Recording	Recording speed	DSR-2116: Maximum 240 ips (NTSC)/200 ips (PAL) DSR-2108: Maximum 120 ips (NTSC)/100 ips (PAL)
	Resolution	NTSC: 704×480 (FULL), 704×240 (HALF), 352×240 (QUAD) PAL: 704×576 (FULL), 704×288 (HALF), 352×288 (QUAD)
	Recording method	Real time recording/CONTINUOUS recording/MOTION recording/ALARM recording/ SCHEDULE recording
	Image quality	5 levels (NETWORK/ECONOMY/BASIC/NORMAL/FINE)
Hard disk		Up to a 540 GB HDD, up to two built-in HDDs
Video input terminal		1.0 V(p-p), 75 Ω BNC (DSR-2116: ×16, DSR-2108: ×8)
Video output terminal		MAIN: BNC ×1, S terminal ×1, VGA ×1 (MAIN BNC and S terminal are mutually exclusive), MON2: BNC ×1
Audio input terminal		RCA ×4
Audio output terminal		RCA ×1
External alarm input terminal		No-voltage make contact (DSR-2116: ×16, DSR-2108: ×8) Refer to P18.
Alarm output terminal		Relay (DC 30 V Max 1A, 125 VAC Max 0.5 A) ×4 Refer to P4.
Network terminal		Interface: RJ-45 (10Base-T/100Base-TX) Protocol: TCP/IP, DHCP, UDP Software: DVR Utility 2000S
Interface		RS485 2-pin ×2
Front USB terminal		1 USB (USB 2.0 only), backup (USB Memory)
Disc drive		1 drive, backup (DVD-R, CD-R/RW)
Remote control		IR remote control Up to 99 controllable
Power supply voltage		100 - 240 VAC at 50/60 Hz
Current consumption		100 - 240 VAC: 4A
Allowable ambient temperature		Operation: 5°C to 40°C, Storage: -10°C to + 50°C
Allowable ambient humidity		0 - 90 %
Dimensions		432 (W) × 89 (H) × 349 (D) mm (Protrusions excluded)
Weight		7.6 kg (with two HDD)

Please note that specifications and unit exterior design are subject to change without notification.

■ Dimensions (unit: mm)

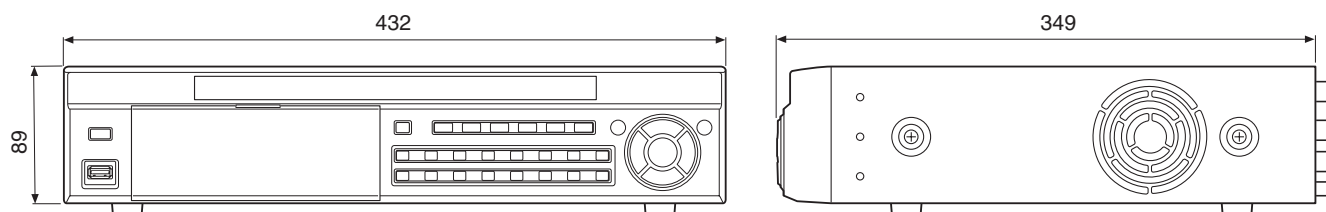

📏 Dimensions of DSR-2116 and DSR-2108 are the same.

■ DVR ID input display list

A	B	C	D	E	F	G	H	I	J	K	L	M	N	O	P	Q	R	S	T
U	V	W	X	Y	Z	[\]	^	'	a	b	c	d	e	f	g	h	
i	j	k	l	m	n	o	p	q	r	s	t	u	v	w	x	y	z	{	
}	~	!	"	#	\$	%	&	'	()	*	+	,	-	.	/	0	1	2
3	4	5	6	7	8	9	:	;	<	=	>	?	@						

Mounting the hard disk (S-ATA)

A hard disk may not be installed at the time of purchase. If no hard disk is installed, consult the dealership where the unit was purchased for purchase and installation.



Make sure the unit is turned off before installing the hard disk.

- 1 Remove the unit's cover.

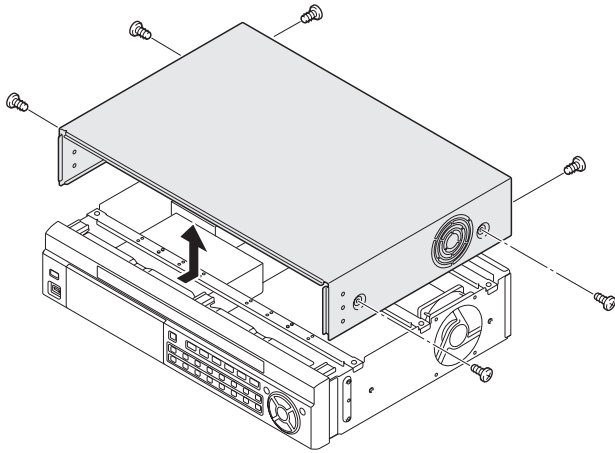

- 2 Fix the supplied rubber pads to the supplied HDD mounting bracket. Then fix the hard disk to the mounting bracket using the supplied screws (A).

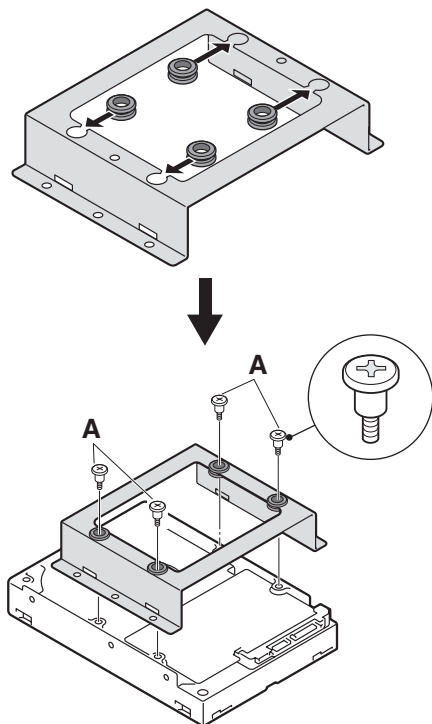

- 3 Connect the unit's power cable (B) and the supplied S-ATA cable (C) to the hard disk. Then fix the hard disk to the unit using the supplied HDD fixing screws (D).

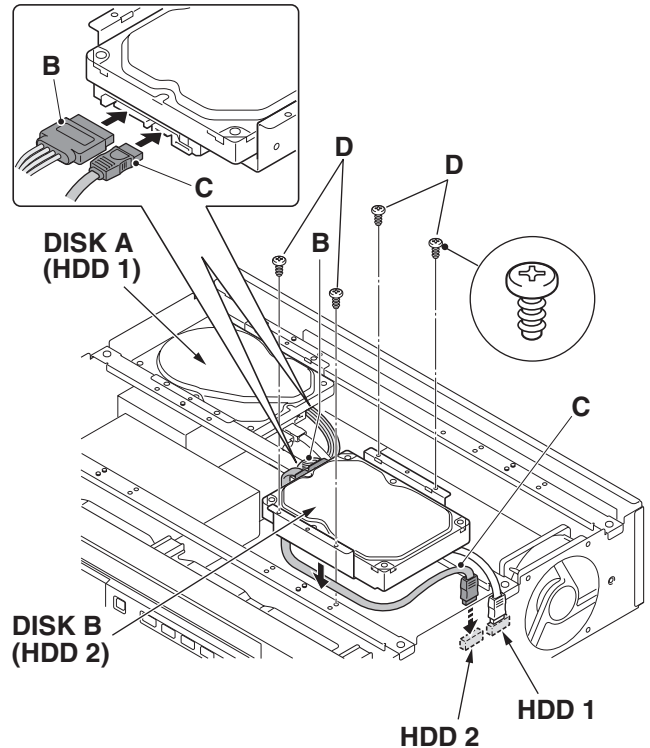

1AC6P1P4015--
L8HBT, L8HBU/XE, US (0609KP-LD)



SANYO Electric Co., Ltd.

Printed in Korea